

# Hydrasearch

## Aerospace Hose & Fittings



# Table of Contents

Hydrasearch Introduction .....	2 - 11
Hydrasearch In The Making.....	2-3
Hydrasearch Capabilities.....	4-5
Legal Policy Information .....	6-7
Using This Catalog .....	8-9
Hydrasearch Hose Fittings Code Chart for Hose Assemblies .....	10
How to Assemble Rubber Hose Assemblies.....	11
<b>Low Pressure .....</b>	<b>12 - 13</b>
Low Pressure Rubber Hose Assemblies .....	12
Low Pressure Rubber Hose Fittings .....	13
<b>Medium Pressure.....</b>	<b>14 - 18</b>
Medium Pressure Rubber Hose Assemblies.....	14
Medium Pressure Rubber Flared Hose Fittings.....	15
Medium Pressure Rubber Flareless Hose Fittings .....	16
Medium Pressure Rubber Flanged Hose Fittings .....	17
Medium Pressure Rubber Fitting Components.....	18
<b>High Pressure .....</b>	<b>19 - 21</b>
High Pressure Rubber Hose Assemblies .....	19
High Pressure Rubber Flared Hose Fittings .....	20
High Pressure Rubber Flareless Hose Fittings.....	21
<b>Medium Pressure TFE.....</b>	<b>22 - 25</b>
Medium Pressure TFE Hose Assemblies .....	22
Medium Pressure TFE Flared Hose Fittings .....	23
Medium Pressure TFE Flareless Hose Fittings.....	24
Medium Pressure TFE Flanged Hose Fittings .....	25
<b>Lightweight Medium Pressure.....</b>	<b>26 - 29</b>
Lightweight Medium Pressure Hose Assemblies.....	26
Lightweight Medium Pressure Flared Hose Fittings .....	27
Lightweight Medium Pressure Flareless Hose Fittings.....	28
Lightweight Medium Pressure Flanged Hose Fittings .....	29
<b>Hose Protectants.....</b>	<b>30 - 31</b>
Chafe Guard, Black TFE.....	30
Chafe Guard, Rubber Neoprene.....	30
Spiral Protective Coil .....	30
Firesleeves.....	31
Heat Shrink Chafe Guard.....	31
Internal Support Spring .....	31
<b>Notes.....</b>	<b>32</b>

## Hydrasearch In The Making

Hydrasearch began in the early 1960s from a growing demand for more “think tank” factories near Washington, D.C. to support our national defense. From hydraulic research and design, to our most recent acquisition of venting solutions, our product offering has been an expanding effort to fulfill the needs of our customers. We are proud to manufacture a trusted product line for almost 60 years.



### 1962

Hydrasearch founded by Willard G. Triest in Annapolis, MD, specializing in the research and manufacturing of hydraulic valves and component devices.

### 1970s

Hydrasearch's primary focus during the 70s was designing hydraulic control systems for the government and fueling at sea equipment for the US Navy.

### 1994

Hydrasearch relocated to Stevensville, Maryland. The new 30,000 square foot facility allowed Hydrasearch to merge its inventory, machining, testing and offices under one roof.

### 1960s

Hydrasearch is acquired by Dixon Valve & Coupling Company, a leading innovator in the hose coupling industry for over 100 years.



### 1980s

Hydrasearch developed and tested a new line of hose and fittings that solved many ongoing leakage problems. This led to Hydrasearch becoming a Qualified Product Listing (QPL) vendor in 1989 by Naval Sea Systems Command.



### 1995

Hydrasearch purchased Technical Products. This acquisition established Hydrasearch as an even larger supplier to the military market.



# Hydrasearch In The Making

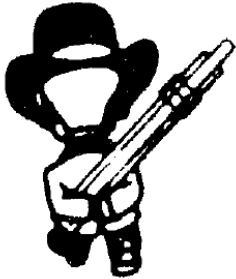

## 1998

Hydrasearch acquired the field attachable hose and fitting product line from Deutsch Metal Components of Gardena, CA. The product line consists of hose assemblies and components.



## 2010

Hydrasearch merged with its sister company Buck Algonquin, under the name Hydrasearch Company, Inc. This merger brought an expansion into the maritime market.



## 2016

Hydrasearch acquired Arctic Steel and Pro-Mar Maritime Venting Solutions. These acquisitions expanded our product offering into the workboat industry.

## 2000

Hydrasearch received its first ISO 9001 certification. The registration is recognized as a measure of a supplier's quality assurance process.

ISO 9001:2000



## 2016

Hydrasearch relocated to its current facility within the same business park in Stevensville, MD. The facility is 65,000 square feet allowing for increased efficiency and production.



## Hydrasearch Capabilities



Founded in 1962, Hydrasearch is a US based manufacturer of specialized maritime/aerospace components, fluid transfer related systems and custom machined parts. We have extensive experience in defense and commercial applications. We support both the immediate needs of daily operational logistics and the long-term dependability required to satisfy OEM production.

### Advantages of buying Hydrasearch

#### Quality Assurance

Hydrasearch maintains a mature quality control process that puts us ahead of the competition. In addition, we are a certified International Organization for Standardization (ISO 9001: 2015) company. To ensure our quality we are continuously improving our equipment, processes and training.

ISO 9001

**BUREAU VERITAS**  
Certification



#### Engineering Support

Hydrasearch has an extensive support system that includes the following programs:

- 3D printing and 3D scanning
- Articulating borescope
- CAD software support
- Coordinate Measuring Machines (CMM)
- Finite element analysis
- Flow simulation
- Comprehensive quality department
- Niton x-ray fluorescence analyzer
- Modern machine shop
- Rapid prototyping
- Solidworks capabilities

## Hydrasearch Capabilities

### A Knowledge Base Built on Experience

Since our inception, Hydrasearch has focused on the design, development and manufacturing of fluid-conveying products and systems. Our first products were specially designed hydraulic systems and fueling at sea systems for the US Navy. Our in depth knowledge of hose fitting designs for demanding applications soon led to the development of innovative hose and couplings and related products that are now part of many diverse fluid handling and fluid power systems.

We have successfully built our business through strict adherence to product design and quality control, interchangeability with existing products, close attention to customer requirements, close attention to delivery needs and competitive pricing. As a result, we have steadily increased our market presence supporting a full range of equipment from helicopters and jets to missiles and rockets.

### Flexible Fluid System Solutions for the Aerospace Industry

Hydrasearch is a leading supplier of fluid system components to the military and commercial aerospace industry. We manufacture a complete range of fitting configurations for a wide variety of hose types, including low, medium and high pressure rubber hose, lightweight medium pressure rubber hose, and medium and high pressure TFE hose. Customers around the world use our products because of the superior design of Hydrasearch hose assemblies to make their flexible fluid systems.

### Quality Control Ensures Reliability

Hydrasearch Company, LLC. is ISO 9001: 2015 certified. The scope of our registration covers the higher Quality Management System for the design, development, manufacture and distribution of fluid systems and components for Military and Commercial customers. Calibration of measuring tools and equipment for final acceptance are traceable to the National Institute of Standards and Technology (NIST) and meet the requirements of ANSI/NCSL Z540-1.

Supplying products that meet strict design and quality standards is only part of our mission. At Hydrasearch, we strive to establish and maintain close relationships with each of our customers. We place an importance on paying attention to details as the needs of our customers depend upon it. When your requirements call for more than a "standard" product, our sales team will work to satisfy those needs.



## Legal Policy Information

### Limited Warranty Policy

#### Right to warn

 In order to ensure proper function of products, it is strongly recommended that each part is inspected and serviced monthly. Inspection should include, but is not limited to, visible damage, excessive wear and proper bonding. Failure to properly maintain your product may result in catastrophic failure and/or loss of life.

#### Limited Warranty

Hydrasearch Company, LLC (herein called "Hydrasearch") warrants the products described herein, and manufactured by Hydrasearch to be free from defects in material and workmanship for a period of one (1) year from the date of invoice by Hydrasearch under normal use and service. Hydrasearch's sole obligation under this warranty is limited to either repairing or replacing, as hereinafter provided, at its option, any product found to Hydrasearch's satisfaction to be defective upon examination by it, provided that such product shall be returned for inspection to Hydrasearch's factory within thirty (30) days after receipt.

The repair or replacement of defective products will be made without charge for parts or labor. This warranty shall not apply to parts or products not manufactured by Hydrasearch, the warranty of such items being limited to the actual warranty extended to Hydrasearch by its supplier.

This warranty shall not apply to any product which has been subject to abuse, negligence, accident or misapplication or to any product which has been altered or repaired by anyone other than Hydrasearch nor to normal maintenance services and the replacement of service items (such as washers, gaskets and lubricants) made in connection with such services.

To the extent permitted by law, this limited warranty shall extend only to the buyer and any other person reasonably expected to use or consume the goods who is injured in person by any breach of warranty. No action may be brought against Hydrasearch for an alleged breach of warranty unless such action is instituted within one (1) year from the date the cause of action accrues. This limited warranty shall be construed and enforced to the fullest extent allowable by applicable law.

Other than the obligation of Hydrasearch expressly set forth herein, Hydrasearch disclaims all warranties, expressed or implied, including but not limited to any implied warranties of merchantability or fitness for a particular purpose, and any other obligation or liability. The foregoing constitutes Hydrasearch's sole obligation with respect to damages, whether direct, incidental or consequential, resulting from their use or performance of the product.

### Proposition 65 Warning

As a company that may sell or distribute Hydrasearch Company, LLC ("Hydrasearch") products to California consumers or to other persons or entities that may sell such items to California consumers, Hydrasearch is obligated to notify you of the following:

Hydrasearch is in compliance with the California Safe Drinking Water and Toxic Enforcement Act of 1986 and its supporting regulations ("Proposition 65"), as it provides warnings that comply with a 2015 court-approved settlement. All Hydrasearch products are shipped in cartons with the following warning:

"WARNING: This product contains lead, a chemical known to the State of California to cause cancer and birth defects or other reproductive harm."

If you sell or distribute Hydrasearch products to California consumers, or to other persons or entities that may sell such items to California consumers, in quantities fewer than a full carton, you must provide this warning to each customer, either by labeling each unit with the above warning, by posting a sign at the point of sale, or by another method.

If you sell Hydrasearch products online to California consumers, you should display this warning message on the product display page, by a clearly marked hyperlink on the product display page, or otherwise prominently displayed to the purchaser before the purchaser completes the purchase of the product.

Hydrasearch will defend and indemnify you if there is a claim made under Proposition 65 for listed chemicals being contained in its products, so long as you have provided the warning per the instructions above. If you sell Hydrasearch products without the warnings we have provided, you are at risk of enforcement and significant penalties.

If you would like more information about the chemicals contained in Hydrasearch products, please visit our website at [www.hydrasearch.com](http://www.hydrasearch.com). Many product display pages contain information about the chemicals contained in our products.

Hydrasearch products made of brass may not be sold to California consumers unless such fittings either contain less than 300 ppm of lead when analyzed pursuant to the EPA test method 3050B or equivalent or they are sold or distributed with a clear, reasonable and conspicuous warning. So long as it is prominently displayed on the product or the packaging of the product, the above warning complies.

Should you need further explanation or assistance in complying with this notice, please do not hesitate to contact us at [compliance@hydrasearch.com](mailto:compliance@hydrasearch.com).

# Legal Policy Information

## Return Policy

Contact your Hydrasearch Company, LLC customer service representative (information below) to obtain a Return Material Authorization (RMA) form. Original invoice number, purchase order number and date must be provided. Product returned without an RMA number may be refused or returned at the customer's expense. Hydrasearch is not liable for unauthorized returns.

### Return Material Authorization (RMA)

- Authorization must be obtained prior to return
- RMA expires thirty (30) days from date issued
- One carton must include a copy of the RMA form to ensure prompt evaluation and possible credit on return
- If credit is applicable, credit may take up to thirty (30) days from receipt of the returned product(s)
- Returned merchandise transportation must be prepaid
- Merchandise must be securely packaged to avoid damage during transit
- All cartons must be marked with authorized RMA number (unmarked shipments will be refused by our receiving department)
- Returned goods should be shipped to the following address:

Hydrasearch Company, LLC  
Returns Dept. RMA # \_\_\_\_\_  
203A Log Canoe Circle  
Stevensville, MD 21666

### Nonconforming Products

- All product will be inspected and processed by our quality department for disposition
- Product(s) shipped in error and/or product(s) deemed nonconforming will be credited at the invoice price paid including freight charges for these items

### Restocking/Unwanted Products

- All product will be inspected and processed by our quality department for disposition
- Restocking charge will apply at a minimum of 25% for all product returned for any other reason than Hydrasearch shipping and/or nonconforming errors
- Product(s) may not be returned unless they are in marketable condition. Any cost incurred to put product(s) in marketable condition will be charged to the customer.
- Product returned damaged/broken will be credited at a scrap value only
- Product returned to Hydrasearch must be prepaid freight at the responsibility of the customer
- Non-inventory product may or may not be authorized for return, based solely on the inventory requirements of Hydrasearch
- Special order product(s) or product that do not have standard requirements, are not eligible for return (*unless product is found to be nonconforming by our quality department*)
- Shaft Couplings must be in original, sealed cartons and in salable condition

### Claims

- Claims for damage or loss in transit must be made by customer directly against the carrier. Hydrasearch is not responsible for freight damage
- Photographic evidence is required for all claims
- All claims for defective product or deficient orders must be made in writing by customer within thirty (30) days of receipt

### Hydrasearch Sales Representatives

Defense

Phone: 410.643.8900

Email: defense@hydrasearch.com

## Limits of Liability and Copyright

This catalog is intended as a product offering. It is not intended to be a user or technical manual. Information in this catalog is subject to change without notice. All users and distributors of products sold through this catalog should contact Hydrasearch with questions of use, compatibilities, coupling procedures and life of product. Our full time engineering and test staff is always available to recommend uses and to assist distributors and users with any questions.

Copyright © 2021 by Hydrasearch Company LLC.

All rights reserved. This catalog is copyrighted material. Use, reproduction or copying of it by anyone other than Hydrasearch is strictly prohibited without express written consent.



## Using This Catalog

### Dimensions

All dimensions shown are approximate and are to be used for reference only. Please contact Hydrasearch Sales at 410.643.8900 when exact dimensions are required.

### Accuracy of Information

Every effort has been made to ensure the accuracy of the information in this catalog. While we cannot assume liability for any errors or omissions, we encourage you to contact our Marketing Department (marketing@hydrasearch.com) with such information, so that the necessary changes can be made.

### Pricing and Availability

Please contact Hydrasearch Sales at defense@hydrasearch.com for pricing and availability information.

### Ordering Information

When ordering, please note that each part number is broken down into seven (7) elements. See figure and key descriptions for explanation of a typical hose assembly part number.



A

**Type of Hose** - Hose type is designated by a two digit number, as follows:

93 = low pressure, rubber

94 = medium pressure, rubber

88 = high pressure, rubber

79 = electrically conductive TFE inner liner with braided stainless steel cover

36 = lightweight medium pressure, rubber

B

**Type of Fitting** - Fitting type is designated by a single letter, as follows:

B = field attachable (reusable fittings)

D = swivel nuts with lock wire holes

F = firesleeve - silicone

H = firesleeve - silicone with lock wire holes in swivel nuts

J = chafe guard - spiral TFE

L = chafe guard with lock wire holes in swivel nuts

X = internal support spring

Y = aluminum with fire sleeve

Z = internal support spring with lock wire holes in swivel nuts

**Note:** For TFE hose assemblies, confirm L, X and Z before using. Special number may apply.

C

**Hose Fitting Combinations** - Hose fitting combinations are designated by a two digit number (see hose fitting combination chart on page 10).

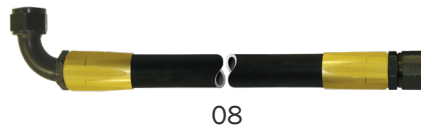
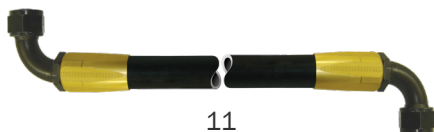

## Using This Catalog

D

**Angular Rotation of Hose Fittings** - Place fitting nearest you at a position of 0° (see illustration). Measure counterclockwise to the desired position of the rear fitting. When the angle between fittings desired is position 0°, specify 000.

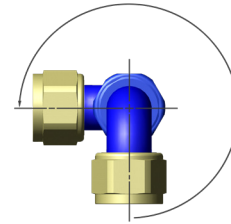

E

**Hose Assembly Size** - Hose assembly size is designated by a two digit number (see chart).

**Note:** Size code  $\frac{3}{16}$  is 34, which consists of a  $\frac{1}{4}$  hose with  $\frac{3}{16}$  fittings.

Fitting Tube Size	Size Code Number
$\frac{1}{8}$	02
$\frac{3}{16}$	03 (B)
$\frac{1}{4}$	04 (E)
$\frac{5}{16}$	05 (F)
$\frac{3}{8}$	06 (G)
$\frac{1}{2}$	08 (H)
$\frac{5}{8}$	10 (J)
$\frac{3}{4}$	12 (K)
1	16 (M)
$1 \frac{1}{4}$	20
$1 \frac{1}{2}$	24
2	32

F

**Fitting Material** - Fitting material is designated by one of the following letters:

### Rubber and Lightweight Medium Pressure

D = all aluminum

F = steel with aluminum sockets

X = steel with aluminum sockets and firesleeve

R = all aluminum with rubber abrasion-resistant sleeve\*

P = steel with aluminum sockets and rubber abrasion-resistant sleeve\*

\*To order rubber guard, type of fitting designation is J, and fitting material is either R or P.

### TFE Hose Assemblies

C = stainless steel fittings

K = chafe guard TFE AS1291 Code A

Z = stainless steel fittings with silicone firesleeve

G

**Length of Assembly** - Hydrasearch hose assemblies are available in  $\frac{1}{8}$  inch increments. The first three digits indicate length in inches. The fourth digit indicates eighths of an inch. (The example and key description on page 8 specifies an assembly 18  $\frac{1}{2}$  inch in length.) Lengths are specified from centerline to centerline of angular fittings, and from end-of-sealing to end-of-sealing surface for straights.

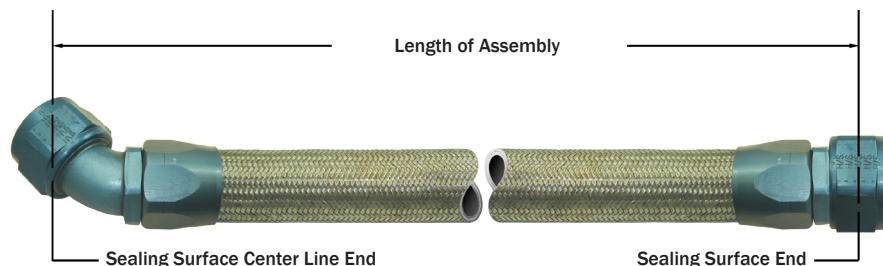

# Hydrasearch Hose Fittings Code Chart for Hose Assemblies

Code No.	First End	First Angle	Second End	Second Angle	Mfg. Method	Code No.	First End	First Angle	Second End	Second Angle	Mfg. Method
01	flare	straight to	flare	straight	bar stock	51	flare	45° to	flange	straight	bent tube
02	flare	straight to	flare	45°	forged	52	flare	45° to	flange	45°	bent tube
03	flare	straight to	flare	90°	forged	53	flare	45° to	flange	90°	bent tube
04	flare	45° to	flare	45°	forged	54	flare	90° to	flange	straight	bent tube
05	flare	45° to	flare	90°	forged	55	flare	90° to	flange	45°	bent tube
06	flare	90° to	flare	90°	forged	56	flare	90° to	flange	90°	bent tube
07	flare	straight to	flare	45°	bent tube	57	flareless	straight to	flareless	straight	bar stock
08	flare	straight to	flare	90°	bent tube	58	flareless	straight to	flareless	45°	bent tube
09	flare	45° to	flare	45°	bent tube	59	flareless	straight to	flareless	90°	bent tube
10	flare	45° to	flare	90°	bent tube	60	flareless	45° to	flareless	45°	bent tube
11	flare	90° to	flare	90°	bent tube	61	flareless	45° to	flareless	90°	bent tube
20	flange	straight to	flange	straight	bar stock	62	flareless	90° to	flareless	90°	bent tube
21	flange	straight to	flange	45°	forged	63	flareless	straight to	flange	straight	bar stock
22	flange	straight to	flange	90°	forged	64	flareless	straight to	flange	45°	bent tube
23	flange	45° to	flange	45°	forged	65	flareless	straight to	flange	90°	bent tube
24	flange	45° to	flange	90°	forged	66	flareless	45° to	flange	straight	bent tube
25	flange	90° to	flange	90°	forged	67	flareless	45° to	flange	45°	bent tube
26	flange	straight to	flange	45°	bent tube	68	flareless	45° to	flange	90°	bent tube
27	flange	straight to	flange	90°	bent tube	69	flareless	90° to	flange	straight	bent tube
28	flange	45° to	flange	45°	bent tube	71	flareless	straight to	flareless	45°	forged
29	flange	45° to	flange	90°	bent tube	72	flareless	straight to	flareless	90°	forged
30	flange	90° to	flange	90°	bent tube	73	flareless	45° to	flareless	45°	forged
40	flare	straight to	flange	straight	bar stock	74	flareless	45° to	flareless	90°	forged
41	flare	straight to	flange	45°	forged	75	flareless	90° to	flareless	90°	forged
42	flare	straight to	flange	90°	forged	82	flareless	straight to	flange	45°	forged
43	flare	45° to	flange	straight	forged	83	flareless	straight to	flange	90°	forged
44	flare	45° to	flange	45°	forged	84	flareless	45° to	flange	straight	forged
45	flare	45° to	flange	90°	forged	85	flareless	45° to	flange	45°	forged
46	flare	90° to	flange	straight	forged	86	flareless	45° to	flange	90°	forged
47	flare	90° to	flange	45°	forged	87	flareless	90° to	flange	straight	forged
48	flare	90° to	flange	90°	forged	88	flareless	90° to	flange	45°	forged
49	flare	straight to	flange	45°	bent tube	89	flareless	90° to	flange	90°	forged
50	flare	straight to	flange	90°	bent tube	98	flareless	90° to	flange	45°	bent tube
						99	flareless	90° to	flange	90°	bent tube

All combinations are not standard in all sizes. The above chart contains all common combinations of fittings listed in this catalog. Special combinations are available upon request.

# How to Assemble Rubber Hose Assemblies

## Low & Medium Pressure Straight Fittings

Low pressure MS27404 fittings with MIL-DTL-5593 hose. Medium pressure MS24587 fittings with MIL-DTL-8794 hose.

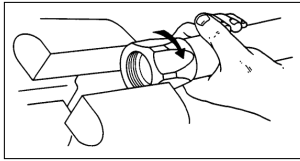

1. After cutting hose squarely to proper length (**DO NOT remove cover**), screw hose into socket (*left hand thread*) until it bottoms. Back out hose  $\frac{1}{4}$  turn.

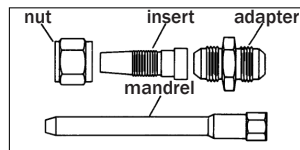

2. Assemble insert and nut on adapter and slide onto mandrel. Tighten nut until assembly is rigid, (*sizes 16 and over do not require a mandrel*).

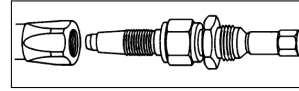

3. Lubricate hose ID and the insert of the sub-assembly (*step 2*) with lubricating oil or light grease.

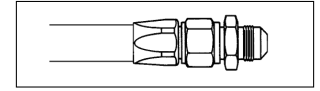

4. Screw sub-assembly (*step 2*) into hose and socket (*step 1*). Leave  $\frac{1}{16}$  inch clearance so nut is free to swivel.

**Clean, Inspect and Test.** Clean the hose assembly by blowing out with air. Inspect the hose by looking through the assembly for any possible obstructions or foreign matter. Pressure test at proof pressure, see page 12 or 14, as applicable.

## Medium Pressure Elbow Fittings

For use with MIL-DTL-8794 hose.

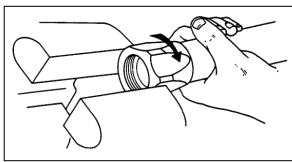

1. After cutting hose squarely to proper length with hacksaw or cutting wheel (**DO NOT remove cover**), screw hose into socket (*left hand thread*) until it bottoms. Back out hose  $\frac{1}{4}$  turn.

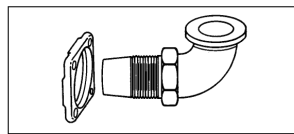

2. **Flange Type Ends Only.** Assemble flange over threaded end of insert. Insert shoulder must seat in counter bore of flange. **Note:** *Step 2 not required for flared/flareless fittings.*

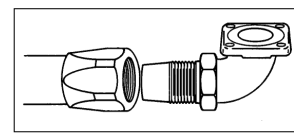

3. Lubricate hose ID and the insert threads with lubricating oil or light grease.

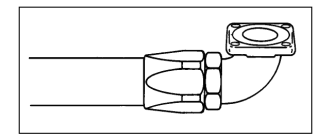

4. Using hex on elbows, screw insert sub-assembly into hose and socket (*step 1*) until insert hex bottoms against socket. **Note:** *On size -32 screw insert into hose and socket until binding occurs. Unscrew and re-lubricate and continue screwing until insert bottoms against socket.*

**Clean and Test.** Clean hose assembly by blowing out with air. Pressure test at proof pressure, see page 14.

## High Pressure All Fittings

For use with MIL-DTL-8788 hose.

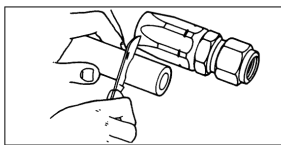

1. Cut hose squarely to proper length with hacksaw or cutting wheel. Match end of hose with notch in hex of socket, measuring back from end of hose the same distance. Cut around hose through cover to wire braid, away from notch in socket.

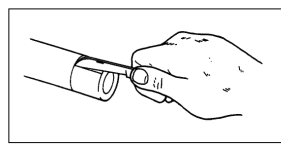

2. Cut lengthwise from cut (*step 1*) to end of hose.

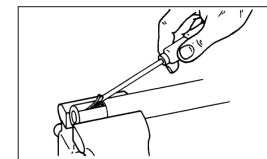

3. Pry up the cover at intersection of the two (2) cuts with a screw driver.

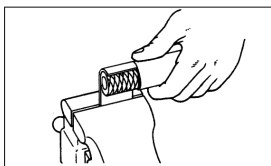

4. Strip off the cover with pliers or vise.

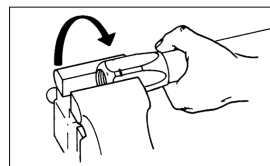

5. Screw the hose into the socket (*left hand thread*) until the hose bottoms. Back out hose  $\frac{1}{4}$  turn.

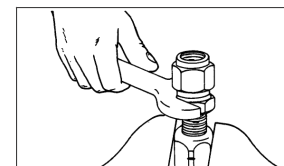

6. Lubricate insert and hose ID with oil. Insert is then threaded into socket and hose until the hex of the insert just touches the socket.

**Clean and Test.** Clean hose assembly by blowing out with air. Pressure test at proof pressure, see page 19.

# Low Pressure Rubber Hose Assemblies

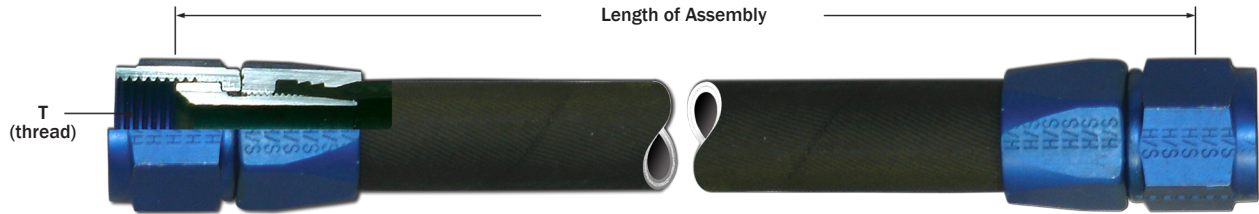

Hydrasearch AN-6270 low pressure hose assemblies can be used as flexible connections on low pressure or vacuum systems such as aircraft instrument systems (see SAE-AIR797). It is especially suited for low pressure hydraulic fluids, engine oils, fuels and coolant fluids. Hydrasearch low pressure hose is used for applications with operating pressures up to 250 PSI, and having a temperature range of -67 °F to +158 °F.

### Specifications for Fittings

**Materials:** Aluminum  
2014-T6 per SAE-AMS 4133 and  
2024-T6 or 2024-T851  
per SAE-AMS-QQ-A-225/6

**Finish:** Aluminum Alloy,  
anodized in accordance with  
MIL-A-8625, Type II.

### Military Specifications

**Fitting:** MIL-DTL-38726 & MS27404

**Hose:** MIL-DTL-5593

**Hose Assembly:** AN6270

### Example of Military Part No.

AN6270-4D-0204

Hydrasearch Part No.	AN Part No.	Hose size	Hose ID	Thread size
93B0100002D0000	AN6270-2D-L	1/8	0.375	5/16 - 24
93B0100003D0000	AN6270-3D-L	3/16	0.188	3/8 - 24
93B0100004D0000	AN6270-4D-L	1/4	0.250	7/16 - 20
93B0100006D0000	AN6270-6D-L	3/8	0.375	9/16 - 18
93B0100008D0000	AN6270-8D-L	1/2	0.500	3/4 - 16
93B01000010D0000	AN6270-10D-L	5/8	0.625	7/8 - 14

## Hydrasearch Low Pressure Hose (in accordance with MIL-DTL-5593)

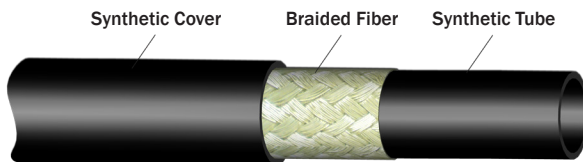

### Identification

Black cover with yellow dot and dash stripe running parallel to bore of hose to indicate natural lay of hose after installing. The letters LP in the stripe indicate low pressure.

The specification PIN, cure date, manufacturer's CAGE code and manufacturer's name or trademark form a part of the lay line and are repeated every 12 inches.

### Operating Systems

- A. Severe vibrating and flexing.
- B. Resistant to engine oil and cleaning solvent externally.
- C. Internal and external temperatures from -67 °F to +158 °F.
- D. Internal fluids, hydraulic fluids, engine oil, fuel, coolant fluids, etc.

### Construction

- A. Inner Tube: Oil and fuel resistant synthetic compound.
- B. Reinforcement: Single cotton braid embedded in bonding material.
- C. Outer Cover: Oil and fuel resistant synthetic compound.

Part No.	Hose size	Inside diameter	Max outside diameter	Max working pressure (PSI)	Proof test pressure (PSI)	Min burst pressure (PSI)	Min bend radius	Hose weight (lbs/ft)
3H-5593-02	1/8	0.125	0.375	300	600	2000	1	0.050
3H-5593-03	3/16	0.188	0.438	250	500	1700	1	0.065
3H-5593-04	1/4	0.250	0.500	200	400	1250	2	0.075
3H-5593-06	3/8	0.375	0.625	150	300	1000	2	0.094
3H-5593-08	1/2	0.500	0.781	150	300	600	3	0.180
3H-5593-10	5/8	0.625	0.906	150	300	600	3	0.210

Note: All dimensions are in inches and are reference only. Variations from these dimensions, on actual parts, may occur as the result of engineering revisions.

# Low Pressure Rubber Hose Fittings

## Straight, Flared

Hydrasearch Part No.	MS Part No.	Hose size	A	B*	T	Weight (pounds)
147-29032	MS27404-2D	1/8	1.094	0.4060	5/16 - 24	0.010
147-29033	MS27404-3D	3/16	1.166	0.4185	3/8 - 24	0.012
147-29034	MS27404-4D	1/4	1.245	0.4435	7/16 - 20	0.020
147-29036	MS27404-6D	3/8	1.374	0.5165	9/16 - 18	0.029
147-29038	MS27404-8D	1/2	1.649	0.6445	3/4 - 16	0.059
147-29040	MS27404-10D	5/8	1.924	0.6915	7/8 - 14	0.074

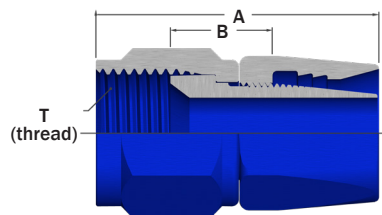

\* Cutoff Factor

## Low Pressure Connector Components

### Insert

Hydrasearch Part No.	Size	H
147-29232	-02	0.062
147-29233	-03	0.125
147-29234	-04	0.172
147-29236	-06	0.297
147-29238	-08	0.391
147-29240	-10	0.484

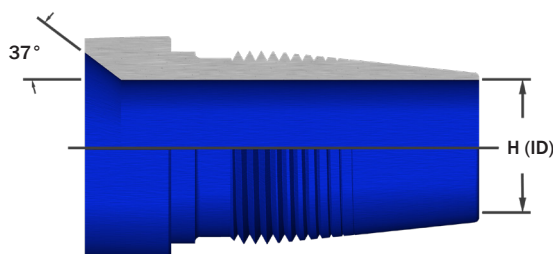

### Nut

AN Part No.*	K	M	T
AN818-2	0.375	0.432	5/16 - 24
AN818-3	0.437	0.506	3/8 - 24
AN818-4	0.562	0.650	7/16 - 20
AN818-6	0.687	0.794	9/16 - 18
AN818-8	0.875	1.010	3/4 - 16
AN818-10	1.000	1.155	7/8 - 14

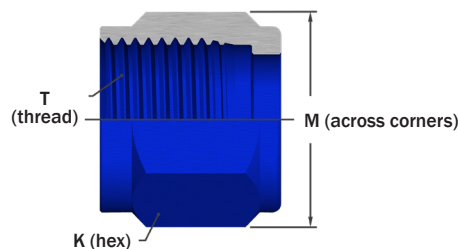

\* Produced to the current MIL specification revision.

### Socket

Hydrasearch Part No.	Size	D	E	F
181-00001-02D	-02	0.531	0.438	0.493
181-00001-03D	-03	0.562	0.500	0.562
181-00001-04D	-04	0.625	0.563	0.625
181-00001-06D	-06	0.773	0.688	0.650
181-00001-08D	-08	0.983	0.875	0.800
181-00001-10D	-10	1.053	0.938	0.950

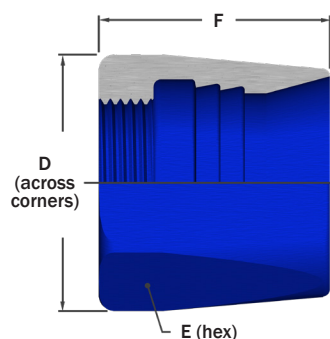

Note: All dimensions are in inches and are reference only. Variations from these dimensions, on actual parts, may occur as the result of engineering revisions.

# Medium Pressure Rubber Hose Assemblies

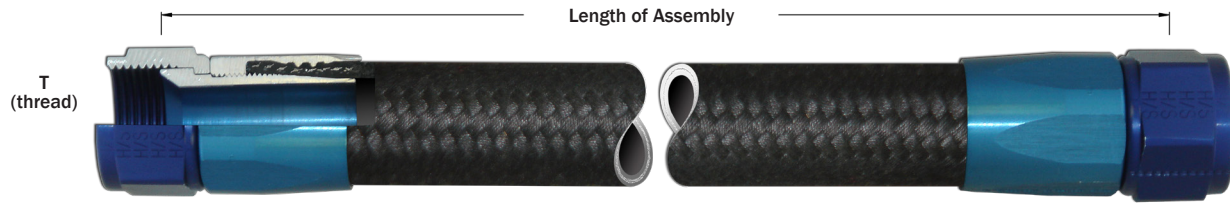

Hydrasearch MS28741 medium pressure hose assemblies can be used as flexible connections on medium pressure power plant and airframe applications (see SAE-AIR797). They are especially suited for medium pressure hydraulic fluids, engine oils, fuels and coolant fluids. Hydrasearch medium pressure hose is used for applications with operating pressures up to 3000 PSI, and having a temperature range of -65 °F to +250 °F. See MIL-DTL-8794 for specific temperature ranges.

Hydrasearch Part No.	MS Part No.	Max operating pressure (PSI)	Min proof pressure (PSI)	Min burst pressure (PSI)	Min bend radius	Hose size	Hose ID	Thread size
94B0100003F0000	MS28741-3-L	1000	1500	4000	3.000	3/16	0.125	3/8 - 24
94B0100004F0000	MS28741-4-L	3000	6000	12000	3.000	1/4	0.188	7/16 - 20
94B0100005F0000	MS28741-5-L	3000	6000	12000	3.375	5/16	0.250	1/2 - 20
94B0100006F0000	MS28741-6-L	2000	4500	9000	4.000	3/8	0.313	9/16 - 18
94B01000080000	MS28741-8-L	2000	4000	8000	4.625	1/2	0.406	3/4 - 16
94B01000100000	MS28741-10-L	1750	3500	7000	5.500	5/8	0.500	7/8 - 14
94B01000120000	MS28741-12-L	1500	3000	6000	6.500	3/4	0.625	1 1/16 - 12
94B01000160000	MS28741-16-L	800	1600	3200	7.375	1	0.875	1 5/16 - 12
94B01000200000	MS28741-20-L	600	1250	2500	9.000	1 1/4	1.125	1 5/8 - 12
94B01000240000	MS28741-24-L	500	1000	2000	11.000	1 1/2	1.375	1 7/8 - 12
94B01000320000	MS28741-32-L	350	700	1400	13.250	2	1.813	2 1/2 - 12

### Specifications for Fittings

**Materials:** Aluminum and steel in accordance with Table 1 of MIL-DTL-5070.

**Finish:** Aluminum Alloy, anodized in accordance with MIL-A-8625, Type II, Class 2.

Steel, cadmium plated (*zinc plating option per ASTM B633 Type II, Fe/Zn 5*) per SAE-AMS-QQ-P-416, Type II, Class II.

**Sizes 3-6** are steel with aluminum sockets.  
**Sizes 8-32** are all aluminum.

### Military Specifications

**Fitting:** MIL-DTL-5070

**Hose:** MIL-DTL-8794

**Hose Assembly:** MIL-DTL-8795

### Example of Military Part No.

**MS28741-4-0204**

Hose assembly, flared, straight fittings, 20 1/2 inch in length, for 1/4 inch tubing.

## Hydrasearch Medium Pressure Hose (in accordance with MIL-DTL-8794)



Hydrasearch Part No.	Hose size	Hose inside diameter min	Approximate OD	Max operating pressure (PSI)	Proof test pressure (PSI)	Min burst pressure (PSI)	Min bend radius	Weight (lbs/ft)
3H-8794-03	3/16	0.125	0.453	3000	6000	12000	3.000	0.12
3H-8794-04	1/4	0.188	0.516	3000	6000	12000	3.000	0.16
3H-8794-05	5/16	0.250	0.578	3000	5000	10000	3.375	0.20
3H-8794-06	3/8	0.313	0.672	2000	4500	9000	4.000	0.23
3H-8794-08	1/2	0.406	0.766	2000	4000	8000	4.625	0.27
3H-8794-10	5/8	0.500	0.922	1750	3500	7000	5.500	0.36
3H-8794-12	3/4	0.625	1.078	1500	3000	6000	6.500	0.44
3H-8794-16	1	0.875	1.234	800	1600	3200	7.375	0.43
3H-8794-20	1 1/4	1.125	1.500	600	1250	2500	9.000	0.51
3H-8794-24	1 1/2	1.375	1.750	500	1000	2000	11.000	0.62
3H-8794-32	2	1.813	2.219	350	700	1400	13.250	0.75

Note: All dimensions are in inches and are reference only. Variations from these dimensions, on actual parts, may occur as the result of engineering revisions.

### Identification

Black cover with yellow line running parallel to bore of hose to indicate natural lay of hose after installing.

The specification PIN, cure date, manufacturer's CAGE code and manufacturer's name or trademark form a part of the lay line and are repeated every 12 inches.

### Operating Systems

- A. Severe vibrating and flexing.
- B. Resistant to engine oil and cleaning solvent externally.
- C. Internal and external temperatures from -65 °F to +250 °F.
- D. Internal fluids, hydraulic fluids, engine oil, fuel, coolant fluids, etc.

### Construction

- A. Inner Tube: Oil and fuel resistant synthetic compound.
- B. Reinforcement: Single wire braid and single cotton braid.
- C. Outer Cover: Oil and fuel resistant synthetic impregnated cotton braid.

# Medium Pressure Rubber Flared Hose Fittings

## Straight, Flared (MS24587)

Complete assembly	MS Part No.	Hose size	A	B*	H	T	Weight (pounds)
148-32003	MS24587-3	3/16	1.298	0.648	0.126	3/8 - 24	0.135
148-32004	MS24587-4	1/4	1.384	0.634	0.126	7/16 - 20	0.155
148-32005	MS24587-5	5/16	1.516	0.736	0.172	1/2 - 20	0.170
148-32006	MS24587-6	3/8	1.656	0.756	0.297	9/16 - 18	0.194
148-32008	MS24587-8	1/2	2.084	0.934	0.392	3/4 - 16	0.090
148-32010	MS24587-10	5/8	2.282	0.992	0.486	7/8 - 14	0.137
148-32012	MS24587-12	3/4	2.566	0.996	0.610	1 1/16 - 12	0.191
148-32016	MS24587-16	1	2.206	0.936	0.815	1 5/16 - 12	0.227
148-32020	MS24587-20	1 1/4	2.347	0.984	1.047	1 5/8 - 12	0.418
148-32024	MS24587-24	1 1/2	2.533	1.078	1.281	1 7/8 - 12	0.510
148-32032	MS24587-32	2	3.074	1.234	1.750	2 1/2 - 12	0.865

\* Cutoff Factor

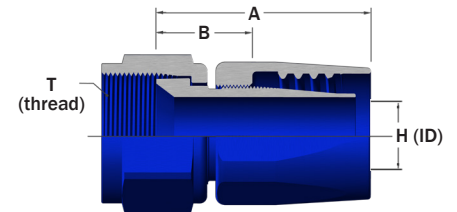

## 45° Elbow, Flared (MS27226, insert assembly only MS27225)

Complete assembly	Insert assembly	Hose size	A	B*	G	H	K	M	R	T	Weight (pounds)
148-1045-03	148-1145-03	3/16	1.80	1.14	0.376	0.126	0.500	0.58	0.38	3/8 - 24	0.163
148-1045-04	148-1145-04	1/4	1.87	1.12	0.352	0.126	0.562	0.65	0.38	7/16 - 20	0.169
148-1045-05	148-1145-05	5/16	2.12	1.34	0.415	0.172	0.625	0.72	0.44	1/2 - 20	0.207
148-1045-06	148-1145-06	3/8	2.28	1.38	0.444	0.234	0.688	0.80	0.50	9/16 - 18	0.212
148-1045-08D	148-1145-08D	1/2	2.70	1.55	0.456	0.358	0.875	1.01	0.50	3/4 - 16	0.117
148-1045-10D	148-1145-10D	5/8	2.99	1.72	0.536	0.455	1.000	1.16	0.62	7/8 - 14	0.160
148-1045-12D	148-1145-12D	3/4	3.46	1.89	0.625	0.579	1.250	1.45	0.84	1 1/16 - 12	0.218
148-1045-16D	148-1145-16D	1	3.11	1.84	0.660	0.815	1.500	1.74	0.97	1 5/16 - 12	0.249
148-1045-20D	148-1145-20D	1 1/4	3.52	2.16	0.768	1.047	1.812	2.09	1.19	1 5/8 - 12	0.391
148-1045-24D	148-1145-24D	1 1/2	3.86	2.40	0.867	1.281	2.125	2.45	1.38	1 7/8 - 12	0.541
148-1045-32D	148-1145-32D	2	4.68	2.84	1.066	1.750	2.750	3.17	1.75	2 1/2 - 12	0.904

\* Cutoff Factor

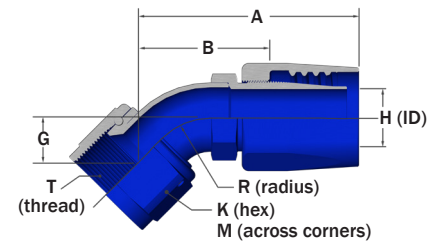

## 90° Elbow, Flared (MS27224, insert assembly only MS27223)

Complete assembly	Insert assembly	Hose size	A	B*	G	H	K	M	R	T	Weight (pounds)
148-1090-03	148-1190-03	3/16	1.64	0.99	0.752	0.126	0.500	0.58	0.38	3/8 - 24	0.165
148-1090-04	148-1190-04	1/4	1.74	0.99	0.718	0.126	0.562	0.65	0.38	7/16 - 20	0.170
148-1090-05	148-1190-05	5/16	1.96	1.18	0.844	0.172	0.625	0.72	0.44	1/2 - 20	0.212
148-1090-06	148-1190-06	3/8	2.13	1.23	0.922	0.234	0.688	0.80	0.50	9/16 - 18	0.232
148-1090-08D	148-1190-08D	1/2	2.54	1.39	0.938	0.358	0.875	1.01	0.50	3/4 - 16	0.115
148-1090-10D	148-1190-10D	5/8	2.82	1.52	1.126	0.455	1.000	1.16	0.62	7/8 - 14	0.165
148-1090-12D	148-1190-12D	3/4	3.34	1.76	1.376	0.579	1.250	1.45	0.84	1 1/16 - 12	0.226
148-1090-16D	148-1190-16D	1	3.02	1.75	1.500	0.815	1.500	1.74	0.97	1 5/16 - 12	0.262
148-1090-20D	148-1190-20D	1 1/4	3.45	2.09	1.782	1.047	1.812	2.09	1.19	1 5/8 - 12	0.413
148-1090-24D	148-1190-24D	1 1/2	3.80	2.34	2.032	1.281	2.125	2.45	1.38	1 7/8 - 12	0.575
148-1090-32D	148-1190-32D	2	4.64	2.80	2.532	1.750	2.750	3.17	1.75	2 1/2 - 12	0.972

\* Cutoff Factor

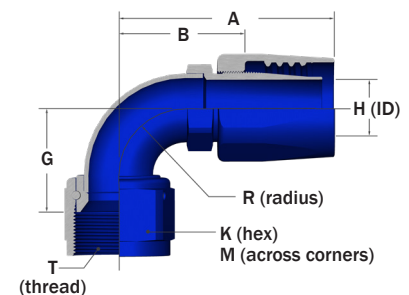

Note: All dimensions are in inches and are reference only. Variations from these dimensions, on actual parts, may occur as the result of engineering revisions.



# Medium Pressure Rubber Flareless Hose Fittings

## Straight, Flareless

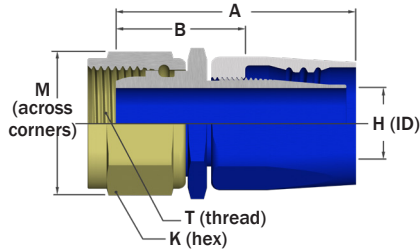

Complete assembly	Insert assembly	A	B*	H	K	M	T	Weight (pounds)
148-2000-03	148-2100-03	1.63	0.98	0.126	0.500	0.58	3/8 - 24	0.153
148-2000-04	148-2100-04	1.68	0.94	0.126	0.562	0.65	7/16 - 20	0.170
148-2000-05	148-2100-05	1.83	1.05	0.172	0.625	0.72	1/2 - 20	0.190
148-2000-06	148-2100-06	2.01	1.11	0.234	0.688	0.80	9/16 - 18	0.225
148-2000-08D	148-2100-08D	2.48	1.33	0.358	0.875	1.01	3/4 - 16	0.124
148-2000-10D	148-2100-10D	2.75	1.46	0.455	1.000	1.16	7/8 - 14	0.161
148-2000-12D	148-2100-12D	3.04	1.47	0.579	1.250	1.45	1 1/16 - 12	0.230
148-2000-16D	148-2100-16D	2.72	1.45	0.815	1.500	1.74	1 5/16 - 12	0.269
148-2000-20D	148-2100-20D	2.92	1.56	1.047	1.812	2.09	1 5/8 - 12	0.408

\* Cutoff Factor

## 45° Elbow, Flareless

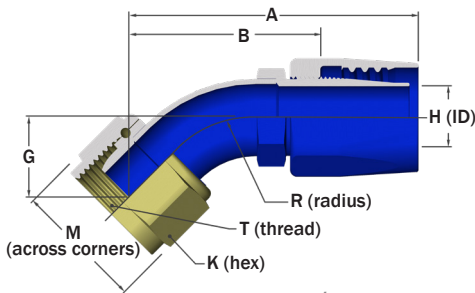

Complete assembly	Insert assembly	A	B*	G	H	K	M	R	T	Weight (pounds)
148-2045-03	148-2145-03	1.95	1.29	0.528	0.126	0.500	0.58	0.38	3/8 - 24	0.063
148-2045-04	148-2145-04	2.10	1.22	0.452	0.126	0.562	0.65	0.38	7/16 - 20	0.070
148-2045-05	148-2145-05	2.35	1.45	0.525	0.172	0.625	0.72	0.44	1/2 - 20	0.107
148-2045-06	148-2145-06	2.55	1.51	0.578	0.234	0.688	0.80	0.50	9/16 - 18	0.131
148-2045-08D	148-2145-08D	3.00	1.71	0.610	0.358	0.875	1.01	0.50	3/4 - 16	0.117
148-2045-10D	148-2145-10D	3.30	1.88	0.725	0.455	1.000	1.16	0.62	7/8 - 14	0.156
148-2045-12D	148-2145-12D	4.05	2.36	0.919	0.579	1.250	1.45	1.25	1 1/16 - 12	0.233
148-2045-16D	148-2145-16D	3.80	2.41	1.010	0.815	1.500	1.74	1.50	1 5/16 - 12	0.270
148-2045-20D	148-2145-20D	4.05	2.58	1.053	1.047	1.812	2.01	1.50	1 5/8 - 12	0.410

\* Cutoff Factor

## 90° Elbow, Flareless

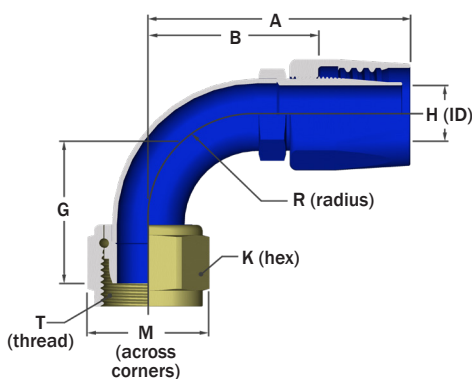

Complete assembly	Insert assembly	A	B*	G	H	K	M	R	T	Weight (pounds)
148-2090-03	148-2190-03	1.64	0.99	0.966	0.126	0.500	0.58	0.38	3/8 - 24	0.065
148-2090-04	148-2190-04	1.74	0.99	0.860	0.126	0.562	0.65	0.38	7/16 - 20	0.071
148-2090-05	148-2190-05	1.97	1.18	1.000	0.172	0.625	0.72	0.44	1/2 - 20	0.121
148-2090-06	148-2190-06	2.13	1.23	1.112	0.234	0.688	0.80	0.50	9/16 - 18	0.136
148-2090-08D	148-2190-08D	2.54	1.39	1.156	0.358	0.875	1.01	0.50	3/4 - 16	0.118
148-2090-10D	148-2190-10D	2.82	1.52	1.392	0.455	1.000	1.16	0.62	7/8 - 14	0.170
148-2090-12D	148-2190-12D	3.74	2.17	2.032	0.579	1.250	1.45	1.25	1 1/16 - 12	0.247
148-2090-16D	148-2190-16D	3.55	2.28	2.306	0.815	1.500	1.74	1.50	1 5/16 - 12	0.292
148-2090-20D	148-2190-20D	3.76	2.40	2.368	1.047	1.812	2.09	1.50	1 5/8 - 12	0.438

\* Cutoff Factor

Note: All dimensions are in inches and are reference only. Variations from these dimensions, on actual parts, may occur as the result of engineering revisions.

# Medium Pressure Rubber Flanged Hose Fittings

## Flange

Part No.*	N	P	S	U
MS20756-12	1.594	1.156	1.125	0.210
MS20756-16	1.750	1.312	1.375	0.210
MS20756-20	2.188	1.656	1.688	0.271
MS20756-24	2.375	1.812	1.938	0.271
MS20756-32	3.000	2.375	2.562	0.333

\* Produced to the current MIL specification revision.

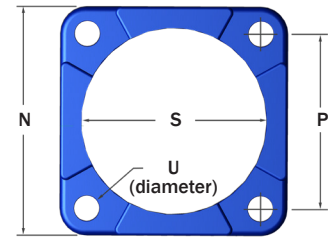

## Straight, Flanged (MS27232, insert assembly only MS27231)

Complete assembly*	Insert assembly*	Hose size	A	B**	H	Weight (pounds)
148-3000-12	148-3100-12	3/4	3.34	1.67	0.579	0.208
148-3000-16	148-3100-16	1	2.90	1.53	0.815	0.228
148-3000-20	148-3100-20	1 1/4	2.98	1.53	1.047	0.347
148-3000-24	148-3100-24	1 1/2	3.02	1.47	1.281	0.403
148-3000-32	148-3100-32	2	3.60	1.66	1.750	0.692

\* Produced to the current MIL specification revision.

\*\* Cutoff Factor

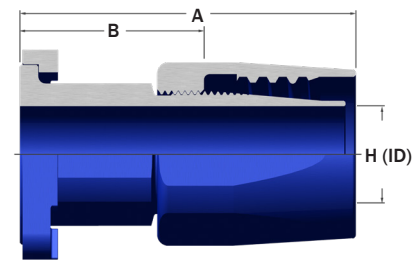

## 45° Elbow, Flanged (MS27230, insert assembly only MS27229)

Complete assembly*	Insert assembly*	Hose size	A	B**	G	H	R	Weight (pounds)
148-3045-12	148-3145-12	3/4	3.43	1.74	0.468	0.579	0.84	0.194
148-3045-16	148-3145-16	1	3.08	1.69	0.505	0.815	0.97	0.206
148-3045-20	148-3145-20	1 1/4	3.45	1.96	0.569	1.047	1.19	0.337
148-3045-24	148-3145-24	1 1/2	3.74	2.16	0.624	1.281	1.38	0.427
148-3045-32	148-3145-32	2	4.47	2.50	0.734	1.750	1.75	0.754

\* Produced to the current MIL specification revision.

\*\* Cutoff Factor

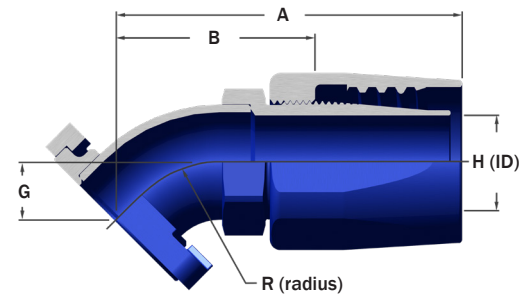

## 90° Elbow, Flanged (MS27228, insert assembly only MS27227)

Complete assembly*	Insert assembly*	Hose size	A	B**	G	H	R	Weight (pounds)
148-3090-12	148-3190-12	3/4	3.46	1.76	1.156	0.579	0.84	0.204
148-3090-16	148-3190-16	1	3.14	1.75	1.282	0.815	0.97	0.229
148-3090-20	148-3190-20	1 1/4	3.57	2.09	1.500	1.047	1.19	0.354
148-3090-24	148-3190-24	1 1/2	3.92	2.34	1.688	1.281	1.38	0.468
148-3090-32	148-3190-32	2	4.76	2.80	2.062	1.750	1.75	0.821

\* Produced to the current MIL specification revision.

\*\* Cutoff Factor

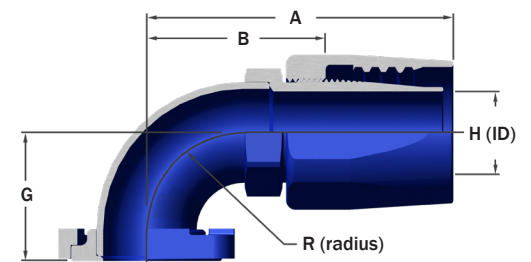

Note: All dimensions are in inches and are reference only. Variations from these dimensions, on actual parts, may occur as the result of engineering revisions.

# Medium Pressure Rubber Fitting Components

## Insert

(MS24588 (-3 to -12) - MS24589 (-16 to -32))

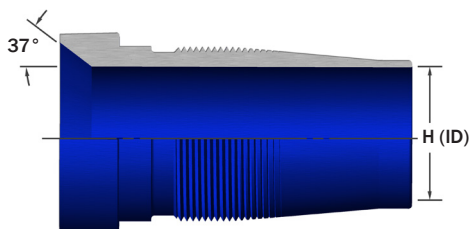

Used for the straight flared fittings seen on page 15.

Hydrasearch Part No.	H
148-32203	0.126
148-32204	0.172
148-32205	0.234
148-32206	0.297
148-32208	0.392
148-32210	0.486
148-32212	0.610
148-32216	0.815
148-32220	1.047
148-32224	1.281
148-32232	1.750

## Socket

(MS24590 (-3 to -12) - MS24591 (-16 to -32))

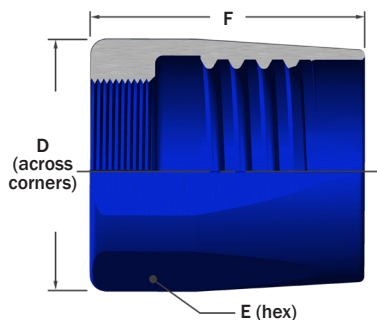

Hydrasearch Part No.	D	E	F
148-32103	0.625	0.563	1.000
148-32104	0.688	0.625	1.100
148-32105	0.750	0.688	1.200
148-32106	0.875	0.813	1.300
148-32108	1.000	0.938	1.650
148-32110	1.219	1.125	1.800
148-32112	1.344	1.250	2.100
148-32116	1.531	1.438	1.661
148-32120	1.906	1.750	1.750
148-32124	2.109	1.938	1.845
148-32132	2.625	2.438	2.250

## Nut (AN818)

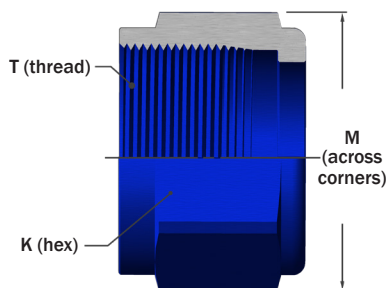

Used for the straight flared fittings seen on page 15.

Hydrasearch Part No.	K	M	T
AN818-3	0.437	0.506	3/8 - 24
AN818-4	0.562	0.650	7/16 - 20
AN818-5	0.625	0.722	1/2 - 20
AN818-6	0.687	0.794	9/16 - 18
AN818-8D	0.875	1.010	3/4 - 16
AN818-10D	1.000	1.155	7/8 - 14
AN818-12D	1.250	1.442	1 1/16 - 12
AN818-16D	1.500	1.730	1 5/16 - 12
AN818-20D	2.000	2.305	1 5/8 - 12
AN818-24D	2.250	2.590	1 7/8 - 12
AN818-32D	2.875	3.310	2 1/2 - 12

Note: All dimensions are in inches and are reference only. Variations from these dimensions, on actual parts, may occur as the result of engineering revisions.

# High Pressure Rubber Hose Assemblies



Hydrasearch MS28759, flared, high pressure hose assemblies can be used as flexible connections on high pressure power plant and airframe applications (see SAE-AIR797). They are especially suited for high pressure hydraulic fluids, engine oils, fuels and coolant fluids. Hydrasearch high pressure hose is used for applications with operating pressures up to 3000 PSI, and having a temperature range of -65 °F to +275 °F (see MIL-DTL-8788 for specific temperature ranges). See the chart to the immediate right for other MIL specification assemblies.

MS to Hydrasearch Hose Assembly Part No. Cross Reference Chart

MS Part No.	Fitting combination	Hydrasearch Part No.
MS28759	straight to straight	88B01000XXFL
MS28762*	straight to straight	88B57000XXFL
MS28920	straight to 45°	88B07000XXFL
MS28921	straight to 90°	88B08000XXFL
MS28922	straight to 45°	88B09000XXFL
MS28923	straight to 90°	88B10000XXFL
MS28924	straight to 90°	88B11000XXFL

"XX" is hose dash size  
\* Flareless

Hydrasearch Part No.	MS Part No.	Size	Hose size	Hose size ID	Max operating pressure (PSI)	Thread size
88B0100004F0000	MS28759-4L	- 04	1/4	0.219	3000	7/16 - 20
88B0100005F0000	MS28759-5L	- 05	5/16	0.281	3000	1/2 - 20
88B0100006F0000	MS28759-6L	- 06	3/8	0.344	3000	9/16 - 18
88B0100008F0000	MS28759-8L	- 08	1/2	0.438	3000	3/4 - 16
88B0100010F0000	MS28759-10L	- 10	5/8	0.563	3000	7/8 - 14
88B0100012F0000	MS28759-12L	- 12	3/4	0.688	3000	1 1/16 - 12
88B0100016F0000	MS28759-16L	- 16	1	0.875	3000	1 5/16 - 12

## Specifications for Fittings

**Materials:** Aluminum and steel in accordance with Table I of MIL-DTL-8789.

**Finish:** Steel, cadmium plated in accordance with AMS-QQ-P-416, Type II, Class 3. Aluminum Alloy, anodized in accordance with MIL-A-8625, Type II, Class 2.

All fittings are steel with aluminum sockets.

## Military Specifications

**Fitting:** MIL-DTL-8789

**Hose:** MIL-DTL-8788

**Hose Assembly:** MIL-DTL-8790

## Example of Military Part No.

**MS28759-40204**

Hose assembly, flared, straight fittings, 20 1/2 inch in length, for 1/4 inch tubing.

## Hydrasearch High Pressure Hose (in accordance with MIL-DTL-8788)

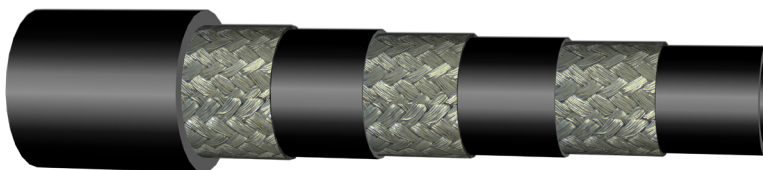

Hydrasearch Part No.	Hose size	Hose ID	Approximate OD	Max operating pressure (PSI)	Proof pressure (PSI)	Min burst pressure (PSI)	Min bend radius	Weight (lbs/ft)
3H-8788-04	1/4	0.219	0.625	3000	8000	16000	3.000	0.219
3H-8788-05	5/16	0.281	0.703	3000	7000	14000	3.375	0.281
3H-8788-06	3/8	0.344	0.766	3000	7000	14000	5.000	0.344
3H-8788-08	1/2	0.438	0.859	3000	7000	14000	5.750	0.438
3H-8788-10	5/8	0.563	1.031	3000	6000	12000	6.500	0.563
3H-8788-12	3/4	0.688	1.219	3000	6000	12000	7.750	0.688
3H-8788-16	1	0.875	1.500	3000	6000	10000	9.625	0.875

Note: All dimensions are in inches and are reference only. Variations from these dimensions, on actual parts, may occur as the result of engineering revisions.

## Identification

Black cover with yellow lay line indicating the specification PIN, cure date, manufacturer's CAGE code and manufacturer's name or trademark running parallel to bore of hose to indicate natural lay of hose after installing.

## Operating Systems

- A. Severe vibrating and flexing.
- B. Resistant to engine oil and cleaning solvent externally.
- C. Internal and external temperatures from -65 °F to +160 °F.
- D. Internal fluids, hydraulic fluids, engine oil, fuel, coolant fluids, etc.

## Construction

- A. Inner Tube: Oil and fuel resistant synthetic compound.
- B. Reinforcement: Sizes 4-12 are double wire braided. Size 16 is triple wire braided.
- C. Outer Cover: Oil and fuel resistant synthetic compound.

# High Pressure Rubber Flared Hose Fittings

## Straight, Flared (MS28760)

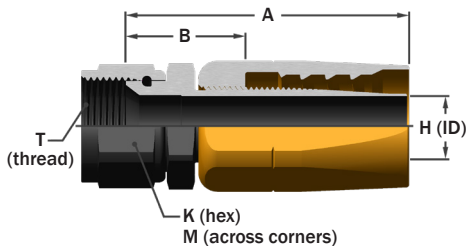

Complete assembly	Insert assembly	Hose size	A	B*	H	K	M	T	Weight (pounds)
149-39270-04	149-39124	1/4	2.018	0.82	0.159	0.562	0.65	7/16 - 20	0.103
149-39270-05	149-39125	5/16	2.158	0.89	0.218	0.625	0.72	1/2 - 20	0.127
149-39270-06	149-39126	3/8	2.405	0.97	0.281	0.688	0.80	9/16 - 18	0.152
149-39270-08	149-39128	1/2	2.710	1.10	0.375	0.875	1.01	3/4 - 16	0.231
149-39270-10	149-39130	5/8	2.905	1.31	0.468	1.000	1.16	7/8 - 14	0.358
149-39270-12	149-39132	3/4	3.175	1.39	0.578	1.250	1.45	1 1/16 - 12	0.555
149-39270-16	149-39136	1	3.775	1.56	0.812	1.500	1.74	1 5/16 - 12	0.825

\* Cutoff Factor

## 45° Elbow, Flared (MS28780)

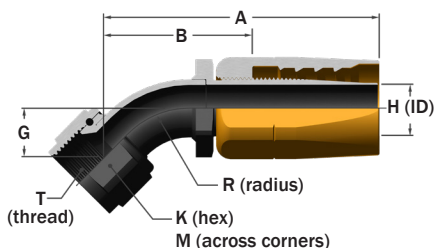

Complete assembly	Insert assembly	Hose size	A	B*	G	H	K	M	R	T	Weight (pounds)
149-1045-04	149-1145-04	1/4	2.284	1.10	0.353	0.159	0.562	0.65	0.38	7/16 - 20	0.115
149-1045-05	149-1145-05	5/16	2.476	1.20	0.415	0.218	0.625	0.72	0.44	1/2 - 20	0.140
149-1045-06	149-1145-06	3/8	2.653	1.26	0.444	0.281	0.688	0.80	0.50	9/16 - 18	0.160
149-1045-08	149-1145-08	1/2	3.033	1.44	0.455	0.375	0.875	1.01	0.50	3/4 - 16	0.240
149-1045-10	149-1145-10	5/8	3.263	1.69	0.536	0.468	1.000	1.16	0.62	7/8 - 14	0.350
149-1045-12	149-1145-12	3/4	3.955	2.25	0.742	0.578	1.250	1.45	1.25	1 1/16 - 12	0.510
149-1045-16	149-1145-16	1	4.653	2.45	0.815	0.812	1.500	1.74	1.50	1 5/16 - 12	0.840

\* Cutoff Factor

## 90° Elbow, Flared (MS28781)

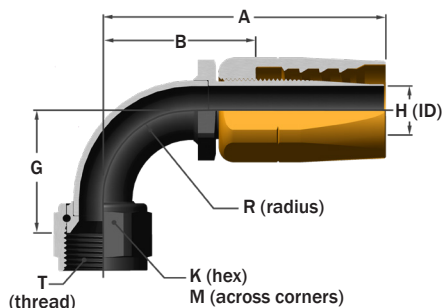

Complete assembly	Insert assembly	Hose size	A	B*	G	H	K	M	R	T	Weight (pounds)
149-1090-04	149-1190-04	1/4	2.14	0.97	0.719	0.159	0.562	0.65	0.38	7/16 - 20	0.116
149-1090-05	149-1190-05	5/16	2.29	1.04	0.844	0.218	0.625	0.72	0.44	1/2 - 20	0.150
149-1090-06	149-1190-06	3/8	2.52	1.14	0.928	0.281	0.688	0.80	0.50	9/16 - 18	0.170
149-1090-08	149-1190-08	1/2	2.87	1.29	0.938	0.375	0.875	1.01	0.50	3/4 - 16	0.255
149-1090-10	149-1190-10	5/8	3.08	1.52	1.125	0.468	1.000	1.16	0.62	7/8 - 14	0.375
149-1090-12	149-1190-12	3/4	3.93	2.24	1.782	0.578	1.250	1.45	1.25	1 1/16 - 12	0.615
149-1090-16	149-1190-16	1	4.70	2.52	2.032	0.812	1.500	1.74	1.50	1 5/16 - 12	0.910

\* Cutoff Factor

Note: All dimensions are in inches and are reference only. Variations from these dimensions, on actual parts, may occur as the result of engineering revisions.

# High Pressure Rubber Flareless Hose Fittings

## Straight, Flareless (MS28761)

Complete assembly	Insert assembly	Hose size	A	B*	H	K	M	T	Weight (pounds)
149-39273-04	149-39104	1/4	2.158	0.993	0.159	0.562	0.65	7/16 - 20	0.104
149-39273-05	149-39105	5/16	2.306	1.056	0.218	0.625	0.72	1/2 - 20	0.125
149-39273-06	149-39106	3/8	2.561	1.186	0.281	0.688	0.80	9/16 - 18	0.141
149-39273-08	149-39108	1/2	2.922	1.347	0.375	0.875	1.01	3/4 - 16	0.242
149-39273-10	149-39110	5/8	3.165	1.603	0.468	1.000	1.16	7/8 - 14	0.379
149-39273-12	149-39112	3/4	3.371	1.681	0.578	1.250	1.45	1 1/16 - 12	0.578
149-39273-16	149-39115	1	4.039	1.854	0.812	1.500	1.74	1 5/16 - 12	0.858

\* Cutoff Factor

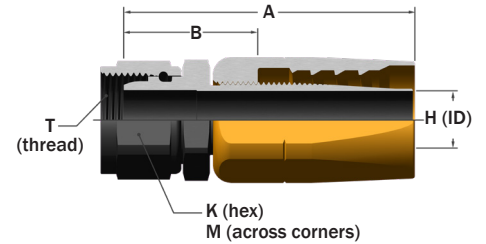

## 45° Elbow, Flareless

Complete assembly	Insert assembly	Hose size	A	B*	G	H	K	M	R	T	Weight (pounds)
149-2045-04	149-2145-04	1/4	2.37	1.20	0.452	0.159	0.562	0.65	0.38	7/16 - 20	0.115
149-2045-05	149-2145-05	5/16	2.57	1.32	0.525	0.218	0.625	0.72	0.44	1/2 - 20	0.143
149-2045-06	149-2145-06	3/8	2.80	1.43	0.578	0.281	0.688	0.80	0.50	9/16 - 18	0.167
149-2045-08	149-2145-08	1/2	3.18	1.61	0.610	0.375	0.875	1.01	0.50	3/4 - 16	0.255
149-2045-10	149-2145-10	5/8	3.44	1.87	0.725	0.468	1.000	1.16	0.62	7/8 - 14	0.370
149-2045-12	149-2145-12	3/4	4.12	2.43	0.919	0.578	1.250	1.45	1.25	1 1/16 - 12	0.595
149-2045-16	149-2145-16	1	4.83	2.65	1.010	0.812	1.500	1.74	1.50	1 5/16 - 12	0.890

\* Cutoff Factor

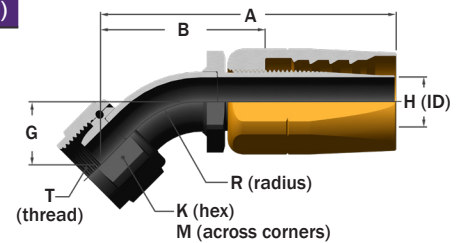

## 90° Elbow, Flareless

Complete assembly	Insert assembly	Hose size	A	B*	G	H	K	M	R	T	Weight (pounds)
149-2090-04	149-2190-04	1/4	2.13	0.97	0.763	0.159	0.562	0.65	0.38	7/16 - 20	0.118
149-2090-05	149-2190-05	5/16	2.30	1.05	0.998	0.218	0.625	0.72	0.44	1/2 - 20	0.153
149-2090-06	149-2190-06	3/8	2.52	1.14	0.978	0.281	0.688	0.80	0.50	9/16 - 18	0.175
149-2090-08	149-2190-08	1/2	2.87	1.29	1.156	0.375	0.875	1.01	0.50	3/4 - 16	0.260
149-2090-10	149-2190-10	5/8	3.08	1.52	1.392	0.468	1.000	1.16	0.62	7/8 - 14	0.395
149-2090-12	149-2190-12	3/4	3.93	2.24	1.875	0.578	1.250	1.45	1.25	1 1/16 - 12	0.640
149-2090-16	149-2190-16	1	4.70	2.52	2.143	0.812	1.500	1.74	1.50	1 5/16 - 12	0.950

\* Cutoff Factor

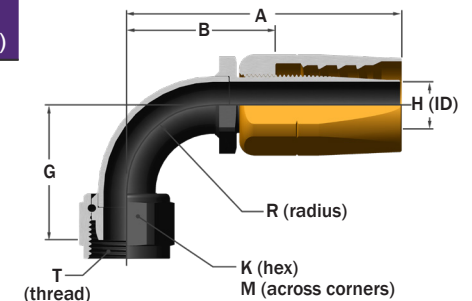

## High Pressure Hose Socket

Part No.	D	E	F
149-39254	0.813	0.750	1.495
149-39255	0.876	0.812	1.600
149-39256	0.943	0.875	1.750
149-39258	1.003	0.938	1.975
149-39260	1.178	1.125	2.062
149-39262	1.391	1.312	2.290
149-39266	1.750	1.625	2.810

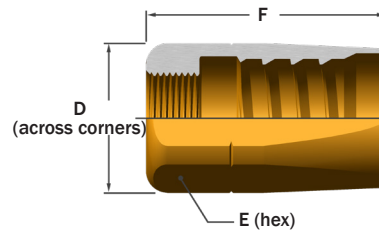

Note: All dimensions are in inches and are reference only. Variations from these dimensions, on actual parts, may occur as the result of engineering revisions.

# Medium Pressure TFE Hose Assemblies

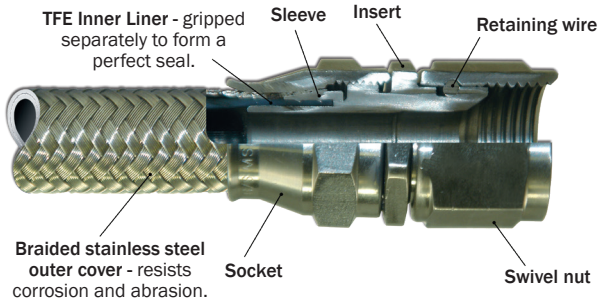

Hose assemblies may be ordered factory assembled. Bulk hose and fittings are available for customer fabricated hose assemblies. Standard hand tools can be used for low volume assembly.

Medium pressure TFE fittings are available in a complete range of sizes and styles including straights, 45°, and 90° elbows, with flared, flareless and flanged type connections. Size -03 fittings adapt to size -04 hose and are identified by either -3/4 or 34. Reuse of sleeves is not recommended.

### Example of Military Part No.

MS8000-E-185-F-A-270

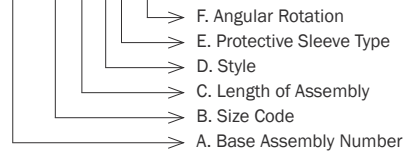

### Specifications for Fittings

**Materials:** Corrosion resistant steel in accordance with MIL-DTL-25579.  
Aluminum option available upon request.

**Finish:** Passivated per SAE-AMS2700.

**Design:** Flared and flareless fittings. Sizes -3 through -8 are forged design. Sizes -10 through -16 are bent tube design. Hydrasearch field-attachable elbow fittings are adjustable in angular rotation through 360°

### Military Specifications

**Fitting:** MIL-DTL-27272

**Hose:** MIL-DTL-27267

**Hose Assembly:** MIL-DTL-25579, MS8000 - MS8004

#### A. Base Assembly Number

MS8000 flared to flared  
MS8001 flareless to flareless  
MS8002 flared to flanged  
MS8003 flareless to flanged  
MS8004 flanged to flanged

#### B. Size Code

B= -3/-4      H= -08  
E= -04      J= -10  
F= -05      K= -12  
G= -06      M= -16

#### C. Length of Assembly

The first two digits indicate inches. The third digit indicates fraction of an inch in eighths.

#### D. Style

Fitting configuration and material (see applicable MS specification).

#### E. Protective Sleeve Type

Protective sleeve type (as required, see MS sheet). Leave blank if not required.

#### F. Angular Rotation

Angular rotation of fittings in degrees.

## High Pressure TFE Hose Assemblies are available upon request.

Fitting: MIL-DTL-83296    Hose: MIL-DTL-83298

## Hydrasearch Medium Pressure TFE Hose (in accordance with MIL-DTL-27267)

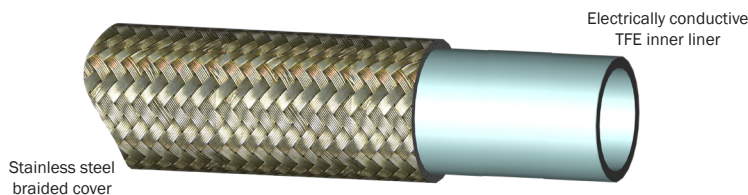

Hydrasearch medium pressure hose is used for applications in aerospace hydraulic and pneumatic systems with operating pressures up to 1500 PSI, and having a temperature range of -65° F to +450° F.

### Unlimited Shelf Life

HS Part No.	Size No.	Hose size	Nominal hose ID	Nominal hose OD	Max operating pressure (PSI)	Min proof pressure (PSI)	Min burst pressure (PSI)	Min high temp burst pressure (PSI)	Min bend radius	Approx. weight (lbs/inch)
3H-379-04	-04	1/4	0.188	0.312	1500	3000	12000	7000	2.00	0.0070
3H-379-05	-05	5/16	0.250	0.375	1500	3000	10000	6500	2.00	0.0076
3H-379-06	-06	3/8	0.313	0.446	1500	3000	9000	6500	4.00	0.0092
3H-379-08	-08	1/2	0.406	0.562	1500	3000	8000	6000	4.63	0.0125
3H-379-10	-10	5/8	0.500	0.656	1500	3000	7000	5500	5.50	0.0157
3H-379-12	-12	3/4	0.625	0.789	1000	2000	5000	3500	6.50	0.0197
3H-379-16	-16	1	0.875	1.109	1250	2500	5000	3500	7.38	0.0437

Hydrasearch TFE hose is unaffected by most aircraft or missile fuels, oils, alcohols, acids, alkalis, coolants, solvents, oxidizers, propellants and high temperature steam used in most aerospace applications. The smooth extruded TFE tube is non-adhesive and has low fluid friction. Additional strength is provided by the tightly braided layers of wire reinforcement.

Note: All dimensions are in inches and are reference only. Variations from these dimensions, on actual parts, may occur as the result of engineering revisions.

# Medium Pressure TFE Flared Hose Fittings

## Straight, Flared (MS27053, insert assembly only MS27061)

Complete assembly	Insert assembly	Hose size	A	B*	H	K	L	T	Weight (pounds)
148-05200-3/-4	148-33291	3/16	1.237	0.72	0.163	0.500	0.562	3/8 - 24	0.065
148-05200-04	148-54757	1/4	1.252	0.74	0.163	0.562	0.562	7/16 - 20	0.071
148-05200-05	148-54758	5/16	1.315	0.77	0.226	0.625	0.625	1/2 - 20	0.086
148-05200-06	148-54759	3/8	1.394	0.81	0.263	0.688	0.688	9/16 - 18	0.121
148-05200-08	148-54760	1/2	1.600	0.94	0.348	0.875	0.875	3/4 - 16	0.225
148-05200-10	148-54761	5/8	1.766	1.06	0.443	1.000	1.000	7/8 - 14	0.262
148-05200-12	148-54762	3/4	1.838	1.14	0.563	1.250	1.250	1 1/16 - 12	0.419
148-05200-16	148-33300	1	2.051	1.31	0.831	1.500	1.500	1 5/16 - 12	0.642

\* Cutoff Factor

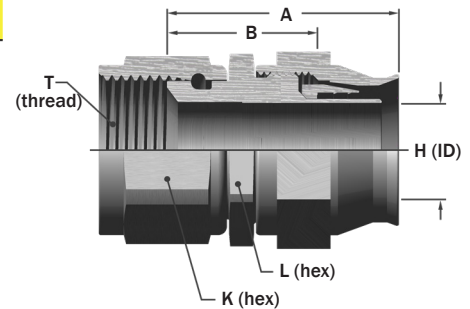

## 45° Elbow, Flared, Forged (MS27059, insert assembly only MS27067)

Complete assembly	Insert assembly	Hose size	A	B*	G	H	K	L	T	Weight (pounds)
148-05212-3/-4	148-33274	3/16	1.66	1.15	0.283	0.163	0.500	0.562	3/8 - 24	0.088
148-05212-04	148-31969	1/4	1.70	1.18	0.322	0.163	0.562	0.562	7/16 - 20	0.097
148-05212-05	148-31970	5/16	1.76	1.22	0.340	0.226	0.625	0.625	1/2 - 20	0.116
148-05212-06	148-31971	3/8	1.86	1.29	0.389	0.263	0.688	0.688	9/16 - 18	0.136
148-05212-08	148-31992	1/2	2.45	1.81	0.465	0.348	0.875	0.875	3/4 - 16	0.269

\* Cutoff Factor

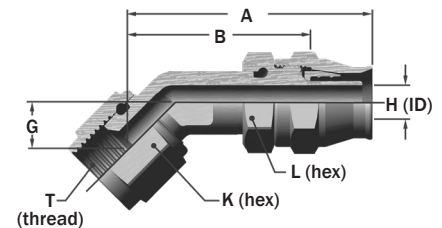

## 45° Elbow, Flared, Bent Tube (MS27055, insert assembly only MS27063)

Complete assembly	Insert assembly	Hose size	A	B*	G	H	K	L	R	T	Weight (pounds)
148-05204-10	148-32775	5/8	2.29	1.58	0.536	0.443	1.000	1.000	0.62	7/8 - 14	0.287
148-05204-12	148-32776	3/4	2.76	2.06	0.623	0.563	1.250	1.125	0.84	1 1/16 - 12	0.462
148-05204-16	148-33368	1	2.99	2.14	0.660	0.831	1.500	1.500	0.97	1 5/16 - 12	0.717

\* Cutoff Factor

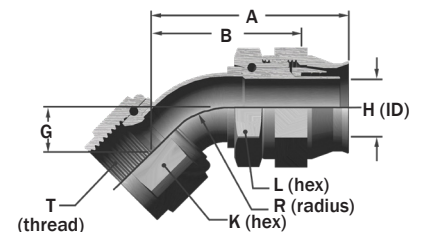

## 90° Elbow, Flared, Forged (MS27060, insert assembly only MS27068)

Complete assembly	Insert assembly	Hose size	A	B*	G	H	K	L	T	Weight (pounds)
148-05214-3/-4	148-33282	3/16	1.43	0.90	0.530	0.163	0.500	0.562	3/8 - 24	0.089
148-05214-04	148-31981	1/4	1.43	0.90	0.580	0.163	0.562	0.562	7/16 - 20	0.100
148-05214-05	148-31982	5/16	1.51	0.97	0.655	0.226	0.625	0.625	1/2 - 20	0.139
148-05214-06	148-31983	3/8	1.60	1.03	0.720	0.263	0.688	0.688	9/16 - 18	0.167
148-05214-08	148-31993	1/2	1.97	1.31	0.830	0.348	0.875	0.875	3/4 - 16	0.277

\* Cutoff Factor

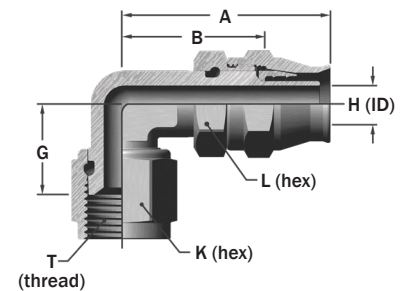

## 90° Elbow, Flared, Bent Tube (MS27057, insert assembly only MS27065)

Complete assembly	Insert assembly	Hose size	A	B*	G	H	K	L	R	T	Weight (pounds)
148-05208-10	148-32655	5/8	2.12	1.41	1.126	0.443	1.000	1.000	0.62	7/8 - 14	0.296
148-05208-12	148-32656	3/4	2.63	1.93	1.376	0.563	1.250	1.125	0.84	1 1/16 - 12	0.485
148-05208-16	148-33348	1	2.77	2.06	1.500	0.831	1.500	1.500	0.97	1 5/16 - 12	0.744

\* Cutoff Factor

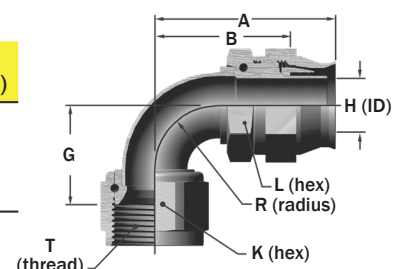

Note: All dimensions are in inches and are reference only. Variations from these dimensions, on actual parts, may occur as the result of engineering revisions.



# Medium Pressure TFE Flareless Hose Fittings

## Straight, Flareless (MS27381, insert assembly only MS27386)

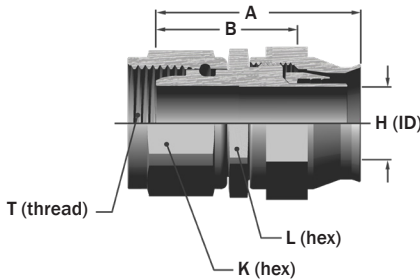

Complete assembly	Insert assembly	Hose size	A	B*	H	K	L	T	Weight (pounds)
148-05216-3/-4	148-33279	3/16	1.708	0.96	0.163	0.500	0.562	3/8 - 24	0.067
148-05216-04	148-30341	1/4	1.662	0.89	0.163	0.562	0.562	7/16 - 20	0.074
148-05216-05	148-30342	5/16	1.808	0.93	0.226	0.625	0.625	1/2 - 20	0.089
148-05216-06	148-30343	3/8	1.697	1.02	0.265	0.688	0.688	9/16 - 18	0.121
148-05216-08	148-30344	1/2	2.097	1.16	0.345	0.875	0.875	3/4 - 16	0.225
148-05216-10	148-30345	5/8	2.085	1.33	0.443	1.000	1.000	7/8 - 14	0.262
148-05216-12	148-30346	3/4	2.471	1.40	0.563	1.250	1.250	1 1/16 - 12	0.419
148-05216-16	148-30347	1	2.720	1.59	0.831	1.500	1.500	1 5/16 - 12	0.642

\* Cutoff Factor

## 45° Elbow, Flareless, Forged (MS27384, insert assembly only MS27389)

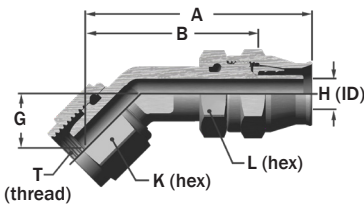

Complete assembly	Insert assembly	Hose size	A	B*	G	H	K	L	T	Weight (pounds)
148-05217-3/-4	148-33174	3/16	1.81	1.18	0.432	0.163	0.500	0.562	3/8 - 24	0.090
148-05217-04	148-07078	1/4	1.80	1.29	0.424	0.163	0.562	0.562	7/16 - 20	0.097
148-05217-05	148-07079	5/16	1.87	1.33	0.448	0.226	0.625	0.625	1/2 - 20	0.105
148-05217-06	148-07080	3/8	1.99	1.43	0.526	0.265	0.688	0.688	9/16 - 18	0.139
148-05217-08	148-07081	1/2	2.62	1.95	0.622	0.348	0.875	0.875	3/4 - 16	0.263

\* Cutoff Factor

## 45° Elbow, Flareless, Bent Tube (MS27382, insert assembly only MS27387)

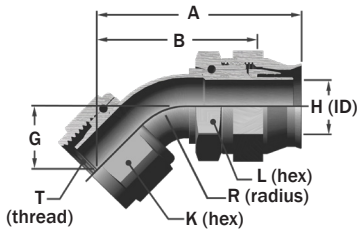

Complete assembly	Insert assembly	Hose size	A	B*	G	H	K	L	R	T	Weight (pounds)
148-05219-10	148-30415	5/8	2.48	1.77	0.725	0.443	1.000	1.000	0.63	7/8 - 14	0.302
148-05219-12	148-30416	3/4	2.93	2.24	0.800	0.563	1.250	1.125	0.84	1 1/16 - 12	0.482
148-05219-16	148-30417	1	3.06	2.481	0.989	0.831	1.500	1.500	0.97	1 5/16 - 12	0.722

\* Cutoff Factor

## 90° Elbow, Flareless, Forged (MS27385, insert assembly only MS27390)

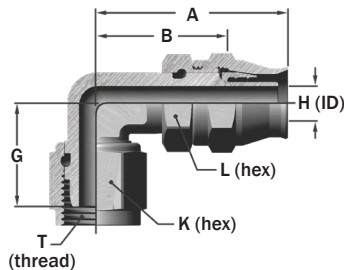

Complete assembly	Insert assembly	Hose size	A	B*	G	H	K	L	T	Weight (pounds)
148-05218-3/-4	148-33175	3/16	1.43	0.90	0.611	0.163	0.500	0.562	3/8 - 24	0.094
148-05218-04	148-07082	1/4	1.43	0.90	0.725	0.163	0.562	0.562	7/16 - 20	0.103
148-05218-05	148-07083	5/16	1.51	0.97	0.808	0.226	0.625	0.625	1/2 - 20	0.141
148-05218-06	148-07084	3/8	1.60	1.03	0.915	0.265	0.688	0.688	9/16 - 18	0.170
148-05218-08	148-07085	1/2	1.97	1.31	1.052	0.348	0.875	0.875	3/4 - 16	0.279

\* Cutoff Factor

## 90° Elbow, Flareless, Bent Tube (MS27383, insert assembly only MS27388)

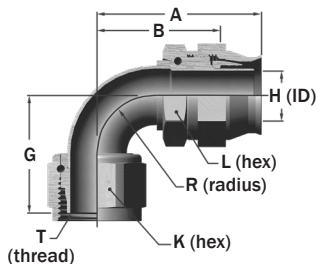

Complete assembly	Insert assembly	Hose size	A	B*	G	H	K	L	R	T	Weight (pounds)
148-05220-10	148-30475	5/8	2.12	1.41	1.392	0.443	1.000	1.000	0.62	7/8 - 14	0.311
148-05220-12	148-30476	3/4	2.63	1.93	1.626	0.563	1.250	1.125	0.84	1 1/16 - 12	0.507
148-05220-16	148-30477	1	2.77	2.06	1.967	0.831	1.500	1.500	0.97	1 5/16 - 12	0.749

\* Cutoff Factor

Note: All dimensions are in inches and are reference only. Variations from these dimensions, on actual parts, may occur as the result of engineering revisions.

# Medium Pressure TFE Flanged Hose Fittings

## Flange (MS27077)

Size	Part No.	U	V	Bolt hole diameter
-08	105-00229	0.950	1.39	0.210
-10	105-00231	1.038	1.47	0.210
-12	105-00187	1.156	1.59	0.210
-16	105-00197	1.312	1.75	0.210

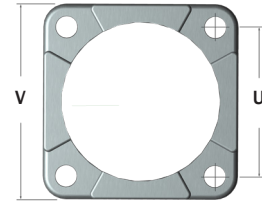

## Straight, Flanged (MS27054, insert assembly only MS27062)

Complete assembly	Insert assembly	Hose size	A	B*	H	L	Weight (pounds)
148-05202-08	148-07045	1/2	1.94	1.27	0.348	0.875	0.353
148-05202-10	148-07046	5/8	2.06	1.35	0.443	1.000	0.361
148-05202-12	148-07047	3/4	2.25	1.55	0.563	1.125	0.377
148-05202-16	148-07048	1	2.34	1.62	0.831	1.500	0.634

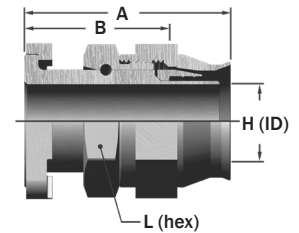

\* Cutoff Factor

## 45° Elbow, Flanged, Bent Tube (MS27056, insert assembly only MS27064)

Complete assembly	Insert assembly	Hose size	A	B*	G	H	L	R	Weight (pounds)
148-05206-08	148-33960	1/2	1.92	1.25	0.338	0.348	0.875	0.500	0.231
148-05206-10	148-33961	5/8	2.13	1.42	0.375	0.443	1.000	0.625	0.299
148-05206-12	148-33916	3/4	2.60	1.90	0.468	0.563	1.125	0.844	0.429
148-05206-16	148-33917	1	2.71	2.00	0.505	0.831	1.500	0.969	0.635

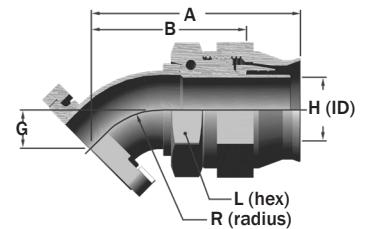

\* Cutoff Factor

## 90° Elbow, Flanged, Bent Tube (MS27058, insert assembly only MS27066)

Complete assembly	Insert assembly	Hose size	A	B*	G	H	L	R	Weight (pounds)
148-05210-08	148-33964	1/2	1.87	1.21	0.772	0.348	0.875	0.500	0.247
148-05210-10	148-33965	5/8	2.12	1.41	0.896	0.443	1.000	0.625	0.307
148-05210-12	148-33924	3/4	2.63	1.92	1.156	0.563	1.125	0.844	0.431
148-05210-16	148-33925	1	2.77	2.05	1.282	0.831	1.500	0.969	0.654

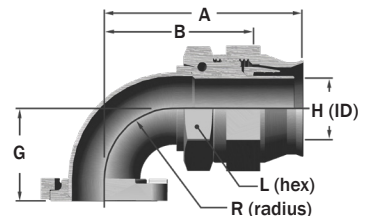

\* Cutoff Factor

## Medium Pressure TFE Socket Assembly Components

### Sleeve (MS27070)

Size	Part No.
-04	148-32911
-05	148-32912
-06	148-32913
-08	148-32914
-10	148-32915
-12	148-32916
-16	148-32917

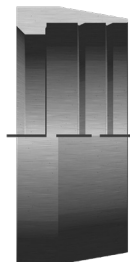

### Socket (MS27069)

Size	Part No.	L	A
-04	148-07032	0.56	0.806
-05	148-07033	0.62	0.834
-06	148-07034	0.69	0.853
-08	148-07035	0.88	0.979
-10	148-07036	1.00	1.080
-12	148-07037	1.13	1.152
-16	148-07038	1.50	1.255

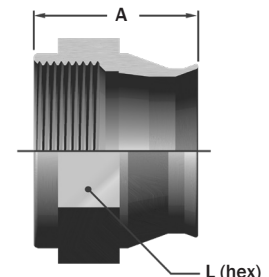

Note: All dimensions are in inches and are reference only. Variations from these dimensions, on actual parts, may occur as the result of engineering revisions.

# Lightweight Medium Pressure Hose Assemblies

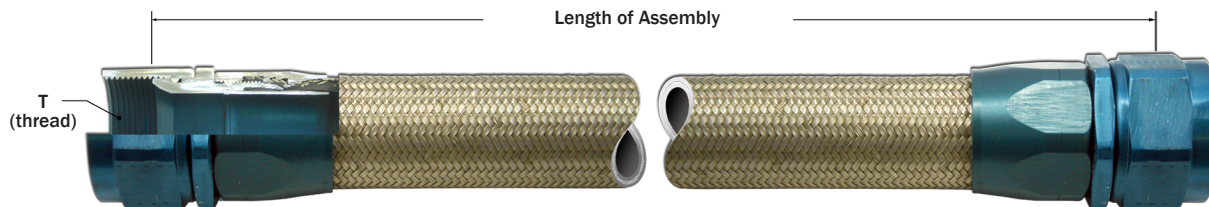

Hydrasearch lightweight hose assemblies can be used as flexible connections in medium pressure airframe applications where flexibility, weight and fire resistance are important. Hydrasearch lightweight hose is used for applications with operating pressures up to 1000 PSI, and having a temperature range of -65 °F to +250 °F (See MIL-DTL-83797 for specific temperature ranges). Not recommended for hydraulic impulse applications or vacuum applications without internal support spring.

### Specifications for Fittings

**Materials:** Sizes 3,4,5 are steel insert assemblies with aluminum sockets. Sizes 6 and up are all aluminum. Steel and Aluminum are to be in accordance with Table I of MIL-DTL-83798.

**Finish:** Aluminum Alloy, anodized in accordance with MIL-A-8625, Type II, Class 2.

Steel, cadmium plated (*zinc plating option per ASTM B633 Type II, Fe/Zn 5*) in accordance with AMS-QQ-P-416.

### Military Specifications

**Fitting:** MIL-DTL-83798

**Hose:** MIL-DTL-83797

**Hose Assembly:** MIL-DTL-83796

### Example of Military Part No.

**M83796/1E185A**

Hose assembly, flared, straight fittings, 18 5/8 inch in length, for 1/4 inch tubing, cadmium plated steel with aluminum sockets.

Hydrasearch Hose Assembly Part No.	Hose size	T Thread size
36B0100003F0000	3/16	3/8 - 24
36B0100004F0000	1/4	7/16 - 20
36B0100005F0000	5/16	1/2 - 20
36B0100006D0000	3/8	9/16 - 18
36B0100008D0000	1/2	3/4 - 16
36B0100010D0000	5/8	7/8 - 14
36B0100012D0000	3/4	1 1/16 - 12
36B0100016D0000	1	1 5/16 - 12
36B0100020D0000	1 1/4	1 5/8 - 12
36B0100024D0000	1 1/2	1 7/8 - 12
36B0100032D0000	2	2 1/2 - 12

## Hydrasearch Lightweight Medium Pressure Hose (in accordance with MIL-DTL-83797)

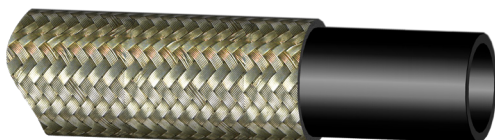

Hydrasearch Part No.	Hose size	Hose ID	Hose OD	Max operating pressure (PSI)	Proof pressure (PSI)	Min burst pressure (PSI)	Min bend radius	Approx. Weight (lbs/inch)
3H-236-03	3/16	0.156	0.376	1000	3000	6000	1.75	0.008
3H-236-04	1/4	0.219	0.440	1000	3000	6000	2.00	0.010
3H-236-05	5/16	0.281	0.486	1000	3000	6000	2.25	0.012
3H-236-06	3/8	0.344	0.549	1000	3000	6000	2.50	0.013
3H-236-08	1/2	0.438	0.651	1000	2500	5000	3.50	0.017
3H-236-10	5/8	0.562	0.797	1000	2500	5000	4.00	0.022
3H-236-12	3/4	0.688	0.938	1000	2000	4000	4.50	0.026
3H-236-16	1	0.875	1.156	750	1500	3000	5.50	0.037
3H-236-20	1 1/4	1.125	1.437	500	1300	2000	8.00	0.051
3H-236-24	1 1/2	1.375	1.703	250	800	1750	9.00	0.069
3H-236-32	2	1.773	2.101	200	600	1200	12.50	0.085

### Identification

Stainless steel wire braid outer cover band with the specification PIN, cure date, manufacturer's CAGE code and manufacturer's name or trademark.

### Applications

Aircraft power plant and airframe oil and fuel lines. Hydraulic applications must have Hydrasearch approval.

### Operating Systems

- A. Severe vibrating and flexing.
- B. Resistant to engine oil and cleaning solvent externally.
- C. Internal and external temperatures from -65 °F to +250 °F.
- D. Hydraulic fluids, engine oil, fuel, coolant fluids, etc.

### Construction

- A. Inner Tube: Synthetic rubber or copolymer.
- B. Reinforcement: Stainless steel wire braid (partial inner braid).
- C. Outer Cover: Full coverage, stainless steel outer braid.

Note: All dimensions are in inches and are reference only. Variations from these dimensions, on actual parts, may occur as the result of engineering revisions.

# Lightweight Medium Pressure Flared Hose Fittings

## Straight, Flared (M83798/1)

Complete assembly	Insert assembly	Hose size	A	B*	H	K	M	T	Weight (pounds)
136-1000-03	137-1000-03	3/16	1.221	0.64	0.111	0.500	0.58	3/8 - 24	0.049
136-1000-04	137-1000-04	1/4	1.246	0.65	0.159	0.562	0.65	7/16 - 20	0.061
136-1000-05	137-1000-05	5/16	1.301	0.70	0.221	0.625	0.72	1/2 - 20	0.078
136-1000-06D	137-1000-06D	3/8	1.426	0.76	0.283	0.688	0.80	9/16 - 18	0.046
136-1000-08D	137-1000-08D	1/2	1.711	0.94	0.378	0.875	1.01	3/4 - 16	0.078
136-1000-10D	137-1000-10D	5/8	1.861	0.99	0.486	1.000	1.16	7/8 - 14	0.108
136-1000-12D	137-1000-12D	3/4	1.931	1.00	0.587	1.250	1.45	1 1/16 - 12	0.160
136-1000-16D	137-1000-16D	1	2.281	1.16	0.791	1.500	1.74	1 5/16 - 12	0.240
136-1000-20D	137-1000-20D	1 1/4	2.561	1.34	1.018	1.812	2.11	1 5/8 - 12	0.372
136-1000-24D	137-1000-24D	1 1/2	2.666	1.44	1.264	2.125	2.48	1 7/8 - 12	0.504
136-1000-32D	137-1000-32D	2	3.076	1.62	1.706	2.750	3.20	2 1/2 - 12	0.900

\* Cutoff Factor

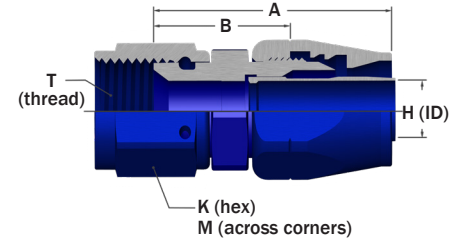

## 45° Elbow, Flared (M83798/2)

Complete assembly	Insert assembly	Hose size	A	B*	G	H	K	M	R	T	Weight (pounds)
136-1045-03	137-1045-03	3/16	1.587	1.02	0.340	0.111	0.500	0.58	0.375	3/8 - 24	0.054
136-1045-04	137-1045-04	1/4	1.573	0.99	0.352	0.159	0.562	0.65	0.375	7/16 - 20	0.073
136-1045-05	137-1045-05	5/16	1.682	1.09	0.415	0.221	0.625	0.72	0.438	1/2 - 20	0.090
136-1045-06D	137-1045-06D	3/8	1.848	1.19	0.446	0.283	0.688	0.80	0.500	9/16 - 18	0.049
136-1045-08D	137-1045-08D	1/2	2.048	1.30	0.457	0.378	0.875	1.01	0.500	3/4 - 16	0.081
136-1045-10D	137-1045-10D	5/8	2.297	1.44	0.536	0.486	1.000	1.16	0.625	7/8 - 14	0.118
136-1045-12D	137-1045-12D	3/4	2.575	1.66	0.623	0.587	1.250	1.45	0.844	1 1/16 - 12	0.180
136-1045-16D	137-1045-16D	1	2.904	1.80	0.660	0.791	1.500	1.74	0.969	1 5/16 - 12	0.263
136-1045-20D	137-1045-20D	1 1/4	3.300	2.10	0.768	1.018	1.812	2.11	1.188	1 5/8 - 12	0.438
136-1045-24D	137-1045-24D	1 1/2	3.526	2.28	0.867	1.264	2.125	2.48	1.375	1 7/8 - 12	0.604
136-1045-32D	137-1045-32D	2	4.136	2.69	1.065	1.706	2.750	3.20	1.750	2 1/2 - 12	1.032

\* Cutoff Factor

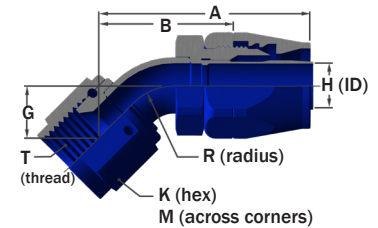

## 90° Elbow, Flared (M83798/3)

Complete assembly	Insert assembly	Hose size	A	B*	G	H	K	M	R	T	Weight (pounds)
136-1090-03	137-1090-03	3/16	1.43	0.86	0.654	0.111	0.500	0.58	0.375	3/8 - 24	0.057
136-1090-04	137-1090-04	1/4	1.44	0.86	0.718	0.159	0.562	0.65	0.375	7/16 - 20	0.071
136-1090-05	137-1090-05	5/16	1.53	0.93	0.844	0.221	0.625	0.72	0.438	1/2 - 20	0.094
136-1090-06D	137-1090-06D	3/8	1.70	1.04	0.922	0.283	0.688	0.80	0.500	9/16 - 18	0.053
136-1090-08D	137-1090-08D	1/2	1.89	1.14	0.938	0.378	0.875	1.01	0.500	3/4 - 16	0.088
136-1090-10D	137-1090-10D	5/8	2.13	1.27	1.126	0.486	1.000	1.16	0.625	7/8 - 14	0.124
136-1090-12D	137-1090-12D	3/4	2.45	1.53	1.376	0.587	1.250	1.45	0.844	1 1/16 - 12	0.189
136-1090-16D	137-1090-16D	1	2.82	1.71	1.500	0.791	1.500	1.74	0.969	1 5/16 - 12	0.267
136-1090-20D	137-1090-20D	1 1/4	3.23	2.03	1.782	1.018	1.812	2.11	1.188	1 5/8 - 12	0.399
136-1090-24D	137-1090-24D	1 1/2	3.47	2.22	2.032	1.264	2.125	2.48	1.375	1 7/8 - 12	0.538
136-1090-32D	137-1090-32D	2	4.10	2.65	2.532	1.706	2.750	3.20	1.750	2 1/2 - 12	0.953

\* Cutoff Factor

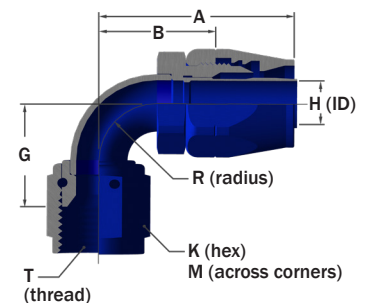

Note: All dimensions are in inches and are reference only. Variations from these dimensions, on actual parts, may occur as the result of engineering revisions.

# Lightweight Medium Pressure Flareless Hose Fittings

## Straight, Flareless (M83798/4)

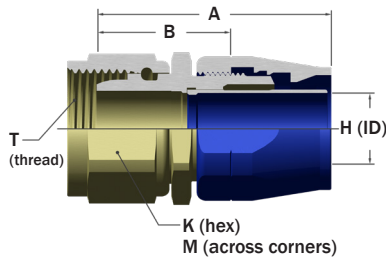

Complete assembly	Insert assembly	Hose size	A	B*	H	K	M	T	Weight (pounds)
136-2000-03	137-2000-03	3/16	1.437	0.85	0.111	0.500	0.58	3/8 - 24	0.051
136-2000-04	137-2000-04	1/4	1.401	0.81	0.159	0.562	0.65	7/16 - 20	0.064
136-2000-05	137-2000-05	5/16	1.464	0.87	0.221	0.625	0.72	1/2 - 20	0.080
136-2000-06D	137-2000-06D	3/8	1.629	0.96	0.283	0.688	0.80	9/16 - 18	0.048
136-2000-08D	137-2000-08D	1/2	1.938	1.17	0.378	0.875	1.01	3/4 - 16	0.082
136-2000-10D	137-2000-10D	5/8	2.136	1.27	0.486	1.000	1.16	7/8 - 14	0.115
136-2000-12D	137-2000-12D	3/4	2.204	1.27	0.587	1.250	1.45	1 1/16 - 12	0.175
136-2000-16D	137-2000-16D	1	2.560	1.44	0.791	1.500	1.74	1 5/16 - 12	0.254
136-2000-20D	137-2000-20D	1 1/4	2.837	1.62	1.018	1.812	2.11	1 5/8 - 12	0.368
136-2000-24D	137-2000-24D	1 1/2	3.112	1.85	1.264	2.125	2.48	1 7/8 - 12	0.513

\* Cutoff Factor

## 45° Elbow, Flareless (M83798/5)

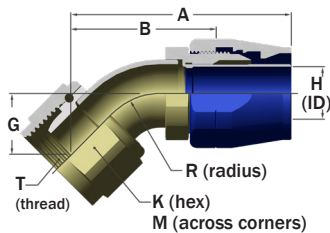

Complete assembly	Insert assembly	Hose size	A	B*	G	H	K	M	R	T	Weight (pounds)
136-2045-03	137-2045-03	3/16	1.74	1.17	0.480	0.111	0.500	0.58	0.375	3/8 - 24	0.059
136-2045-04	137-2045-04	1/4	1.68	1.09	0.450	0.159	0.562	0.65	0.375	7/16 - 20	0.081
136-2045-05	137-2045-05	5/16	1.80	1.20	0.525	0.221	0.625	0.72	0.438	1/2 - 20	0.099
136-2045-06D	137-2045-06D	3/8	1.99	1.33	0.578	0.283	0.688	0.80	0.500	9/16 - 18	0.054
136-2045-08D	137-2045-08D	1/2	2.21	1.45	0.610	0.378	0.875	1.01	0.500	3/4 - 16	0.088
136-2045-10D	137-2045-10D	5/8	2.49	1.63	0.725	0.486	1.000	1.16	0.625	7/8 - 14	0.125
136-2045-12D	137-2045-12D	3/4	2.76	1.84	0.800	0.587	1.250	1.45	0.844	1 1/16 - 12	0.189
136-2045-16D	137-2045-16D	1	3.10	1.99	0.854	0.791	1.500	1.74	0.969	1 5/16 - 12	0.270
136-2045-20D	137-2045-20D	1 1/4	3.50	2.29	0.962	1.018	1.812	2.11	1.188	1 5/8 - 12	0.460
136-2045-24D	137-2045-24D	1 1/2	3.82	2.57	1.155	1.264	2.125	2.48	1.375	1 7/8 - 12	0.635

\* Cutoff Factor

## 90° Elbow, Flareless (M83798/6)

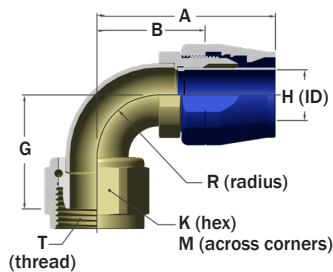

Complete assembly	Insert assembly	Hose size	A	B*	G	H	K	M	R	T	Weight (pounds)
136-2090-03	137-2090-03	3/16	1.43	0.86	0.867	0.111	0.500	0.58	0.375	3/8 - 24	0.061
136-2090-04	137-2090-04	1/4	1.44	0.86	0.860	0.159	0.562	0.65	0.375	7/16 - 20	0.075
136-2090-05	137-2090-05	5/16	1.53	0.93	1.000	0.221	0.625	0.72	0.438	1/2 - 20	0.100
136-2090-06D	137-2090-06D	3/8	1.70	1.04	1.112	0.283	0.688	0.80	0.500	9/16 - 18	0.057
136-2090-08D	137-2090-08D	1/2	1.89	1.14	1.156	0.378	0.875	1.01	0.500	3/4 - 16	0.092
136-2090-10D	137-2090-10D	5/8	2.13	1.27	1.392	0.486	1.000	1.16	0.625	7/8 - 14	0.130
136-2090-12D	137-2090-12D	3/4	2.45	1.53	1.626	0.587	1.250	1.45	0.844	1 1/16 - 12	0.199
136-2090-16D	137-2090-16D	1	2.82	1.71	1.776	0.791	1.500	1.74	0.969	1 5/16 - 12	0.282
136-2090-20D	137-2090-20D	1 1/4	3.23	2.03	2.056	1.018	1.812	2.11	1.188	1 5/8 - 12	0.431
136-2090-24D	137-2090-24D	1 1/2	3.47	2.22	2.440	1.264	2.125	2.48	1.375	1 7/8 - 12	0.559

\* Cutoff Factor

Note: All dimensions are in inches and are reference only. Variations from these dimensions, on actual parts, may occur as the result of engineering revisions.

# Lightweight Medium Pressure Flanged Hose Fittings

## Straight, Flanged (M83798/7)

Complete assembly	Insert assembly	Hose size	A	B*	H	Weight (pounds)
136-3000-8D	138-3000-08D	1/2	1.791	1.041	0.378	0.099
136-3000-10D	138-3000-10D	5/8	1.206	0.351	0.486	0.122
136-3000-12D	138-3000-12D	3/4	2.151	1.236	0.587	0.153
136-3000-16D	138-3000-16D	1	2.421	1.316	0.791	0.206
136-3000-20D	138-3000-20D	1 1/4	2.696	1.496	1.018	0.316
136-3000-24D	138-3000-24D	1 1/2	2.711	1.461	1.264	0.364
136-3000-32D	138-3000-32D	2	2.948	1.503	1.706	0.646

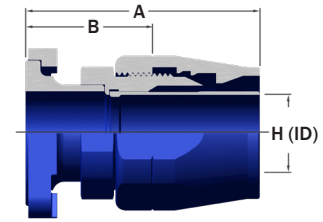

\* Cutoff Factor

## 45° Elbow, Flanged (M83798/8)

Complete assembly	Insert assembly	Hose size	A	B*	G	H	R	Weight (pounds)
136-3045-8D	138-3045-08D	1/2	1.89	1.21	0.370	0.378	0.500	0.103
136-3045-10D	138-3045-10D	5/8	2.15	1.29	0.400	0.486	0.620	0.129
136-3045-12D	138-3045-12D	3/4	2.42	1.50	0.468	0.587	0.844	0.157
136-3045-16D	138-3045-16D	1	2.75	1.64	0.505	0.791	0.969	0.208
136-3045-20D	138-3045-20D	1 1/4	3.10	1.90	0.569	1.018	1.188	0.321
136-3045-24D	138-3045-24D	1 1/2	3.28	2.03	0.625	1.264	1.375	0.386
136-3045-32D	138-3045-32D	2	3.80	2.36	0.734	1.684	1.750	0.672

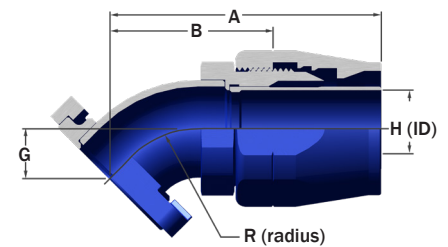

\* Cutoff Factor

## 90° Elbow, Flanged (M83798/9)

Complete assembly	Insert assembly	Hose size	A	B*	G	H	R	Weight (pounds)
136-3090-8D	138-3090-08D	1/2	1.28	1.14	0.810	0.378	0.500	0.106
136-3090-10D	138-3090-10D	5/8	2.00	1.20	0.940	0.486	0.620	0.133
136-3090-12D	138-3090-12D	3/4	2.45	1.53	1.156	0.587	0.844	0.164
136-3090-16D	138-3090-16D	1	2.82	1.71	1.282	0.791	0.969	0.222
136-3090-20D	138-3090-20D	1 1/4	3.23	2.03	1.500	1.018	1.188	0.344
136-3090-24D	138-3090-24D	1 1/2	3.47	2.22	1.688	1.264	1.375	0.448
136-3090-32D	138-3090-32D	2	4.10	2.65	2.062	1.684	1.750	0.732

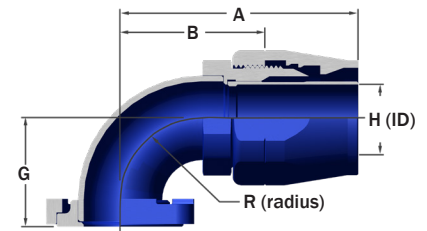

\* Cutoff Factor

## Lightweight Medium Pressure Hose Socket

Part No.	D	E	F
136-900-03D	0.635	0.562	0.790
136-900-04D	0.688	0.625	0.800
136-900-05D	0.750	0.688	0.820
136-900-06D	0.812	0.750	0.900
136-900-08D	0.969	0.875	1.090
136-900-10D	1.156	1.062	1.175
136-900-12D	1.281	1.188	1.245
136-900-16D	1.593	1.500	1.485
136-900-20D	1.891	1.750	1.650
136-900-24D	2.094	1.938	1.700
136-900-32D	2.703	2.500	1.895

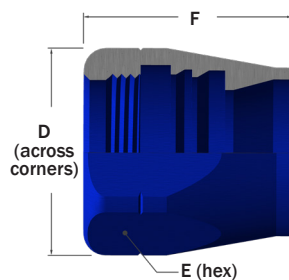

## Flange

Part No.*	N	P	S	U
MS20756-12	1.594	1.156	1.125	0.210
MS20756-16	1.750	1.312	1.375	0.210
MS20756-20	2.188	1.656	1.688	0.271
MS20756-24	2.375	1.812	1.938	0.271
MS20756-32	3.000	2.375	2.562	0.333

\* Produced to the current MIL specification revision.

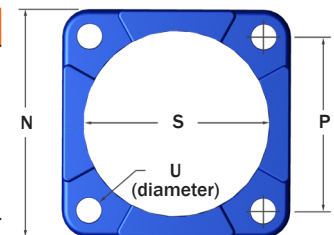

Note: All dimensions are in inches and are reference only. Variations from these dimensions, on actual parts, may occur as the result of engineering revisions.

# Hose Protectants, Coils and Sleeves

## Chafe Guard, Black TFE

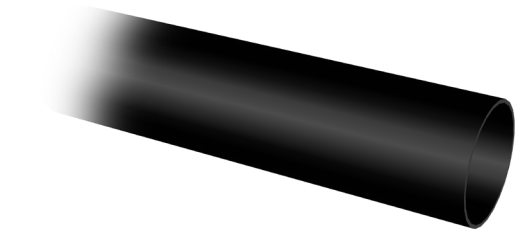

Resistant to most oils, fuels and acids. Temperature range of -65 °F to +450 °F. Conforms to AS1291 Code B.

**Additional Options:**

White TFE chafe guard, AS1291 Code A  
Clear FEP chafe guard, AS1291 Code C

Part No.	ID nominal	ID min	OD nominal
150-60000-01	0.295	0.280	0.355
150-60000-02	0.368	0.353	0.428
150-60000-03	0.429	0.414	0.489
150-60000-04	0.495	0.480	0.555
150-60000-05	0.620	0.605	0.680
150-60000-06	0.723	0.708	0.783
150-60000-07	0.767	0.752	0.827
150-60000-08	0.845	0.830	0.905
150-60000-09	0.940	0.925	1.000
150-60000-10	1.097	1.082	1.157
150-60000-11	1.185	1.170	1.245
150-60000-12	1.378	1.363	1.438
150-60000-13	1.425	1.410	1.485
150-60000-14	1.746	1.731	1.806

## Chafe Guard, Rubber Neoprene



Hydrasearch 148-14593 protective sleeve is a fuel, oil and ozone resistant, Neoprene chafe guard. The sleeve protects hose assemblies from abrasion and scuffing in ground servicing or airborne applications through a temperature range of -65 °F to +250 °F.

Chafe Guard Size															
148-14593	-6	-8	-10	-12	-14	-16	-18	-20	-22	-24	-26	-28	-30	-34	-36
ID	0.39	0.46	0.49	0.57	0.63	0.68	0.72	0.80	0.85	0.94	1.03	1.22	1.29	1.44	1.65
Wall Thickness	0.035	0.035	0.040	0.040	0.040	0.040	0.050	0.050	0.050	0.050	0.050	0.050	0.060	0.070	0.070

## Spiral Protective Coil

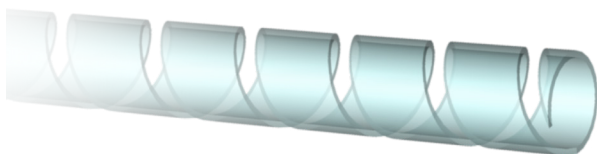

May be applied to hoses in the field by spirally wrapping or winding around the hose. The natural grab between coils reduces the possibility of entrapped moisture. One size covers hose sizes through -20.

$$\text{Required Inches of Spiral Chafe Guard per Inch of Covered Hose} = \frac{\text{OD of Hose}}{0.190} \times \frac{0.375}{0.75 + \text{GAP}}$$

Installed gap of 0.250 recommended.

**Available Options:**

White TFE spiral protective coil is resistant to most oils, fuels and acids. Temperature range of -450 °F to +500 °F.

Black Nylon spiral protective coil resistant to most oils, fuels and weak acids. Temperature range of -145 °F to +230 °F.

Part No.	Material thickness	Band width	Weight (lbs/ft)
148-14615-1	0.030	0.375	0.019

Note: All dimensions are in inches and are reference only. Variations from these dimensions, on actual parts, may occur as the result of engineering revisions.

# Hose Protectants, Coils and Sleeves

## Firesleeves

Part No.	ID nominal	ID min	OD max	Weight (lbs/ft)	AS1072 size
148-14502F	0.44	0.41	0.78	0.13	-07
148-14503F	0.50	0.46	0.84	0.14	-08
148-14504F	0.56	0.52	0.90	0.16	-09
148-14505F	0.62	0.58	0.97	0.20	-10
148-14506F	0.69	0.65	1.03	0.21	-11
148-14507F	0.75	0.71	1.09	0.22	-12
148-14508F	0.88	0.84	1.22	0.26	-14
148-14509F	1.00	0.96	1.38	0.33	-16
148-14510F	1.12	1.08	1.50	0.35	-18
148-14511F	1.25	1.21	1.59	0.37	-20
148-14512F	1.38	1.34	1.75	0.44	-22
148-14513F	1.50	1.46	1.90	0.48	-24
148-14514F	1.62	1.58	1.95	0.38	-26
148-14515F	1.75	1.71	2.06	0.42	-28
148-14516F	1.88	1.84	2.19	0.44	-30
148-14517F	2.00	1.96	2.32	0.48	-32
148-14518F	2.63	2.59	3.03	0.78	none

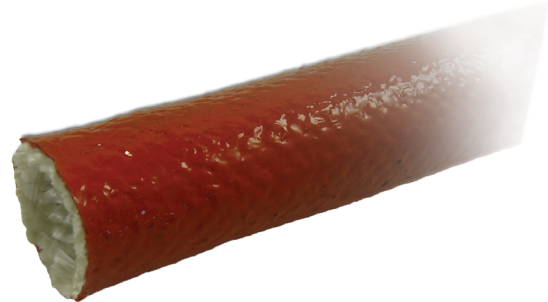

In accordance with AS1072.

Meets FAA TSO C53, TSO C75 and FAA TSO C42 standards.

Silicone impregnated fiberglass braid provides increased service life under conditions of ambient temperatures -65 °F to 450 °F, intermittent to 500 °F and is resistant to most aircraft fuels, oils and hydraulic fluids, including Skydrol 500 (a Monsanto trademark).

## Heat Shrink Chafe Guard

Type	Hose type used on	Hydrasearch Part No.	Military/Aerospace Part No.
polyolefin black	3H-379	148-46150	AS1073-*B
	3H-236		
	3H-238		
polyolefin clear	3H-379	148-47470	AS1073-*A
	3H-236		
	3H-238		
FEP black	3H-379	148-47870	SAE-AMSDTL23053/11-* *-O
FEP clear	3H-379	150-60001	SAE-AMSDTL23053/11-* *-C

\* Size indicated here

\*\* Indicates class and size

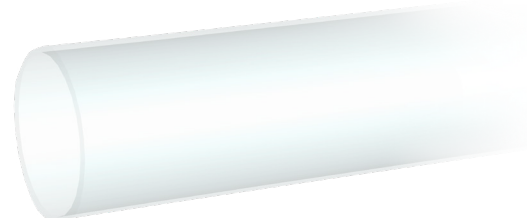

Provides hose assemblies with skin-tight protection against heat, corrosion, shock, moisture and other conditions. Prolongs the service life of the assembly.

## Internal Support Spring

Spring Assembly Part No.	Spring OD
148-14599	0.630
148-14595	0.890
148-14596	1.140
148-14597	1.398
148-14598	1.796

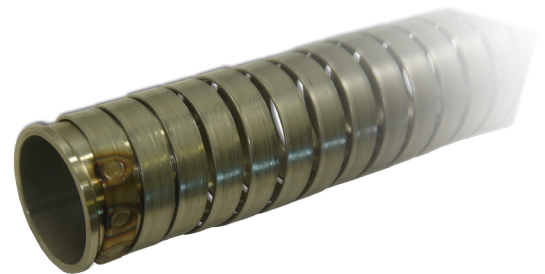

Used to prevent damage to assemblies subject to mishandling, high vacuum, or tight bend installations. Made of flat helically wound type 302 stainless steel. Sleeves spot welded to end of spring to prevent damage of ID of hoses. Internal Support Springs are supplied as assemblies of fixed length and diameter. Specify type and size of hose, configuration of hose fittings and length of assembly.

Note: All dimensions are in inches and are reference only. Variations from these dimensions, on actual parts, may occur as the result of engineering revisions.







# Hydrasearch

## Catalog 222

Proud ISO 9001: 2015  
certified company.



Hydrasearch Company, LLC  
203A Log Canoe Circle, Stevensville, MD 21666  
Phone: 410-643-8900 ▪ Fax: 410-643-8954  
defense@hydrasearch.com ▪ www.hydrasearch.com